



DLP® Projector

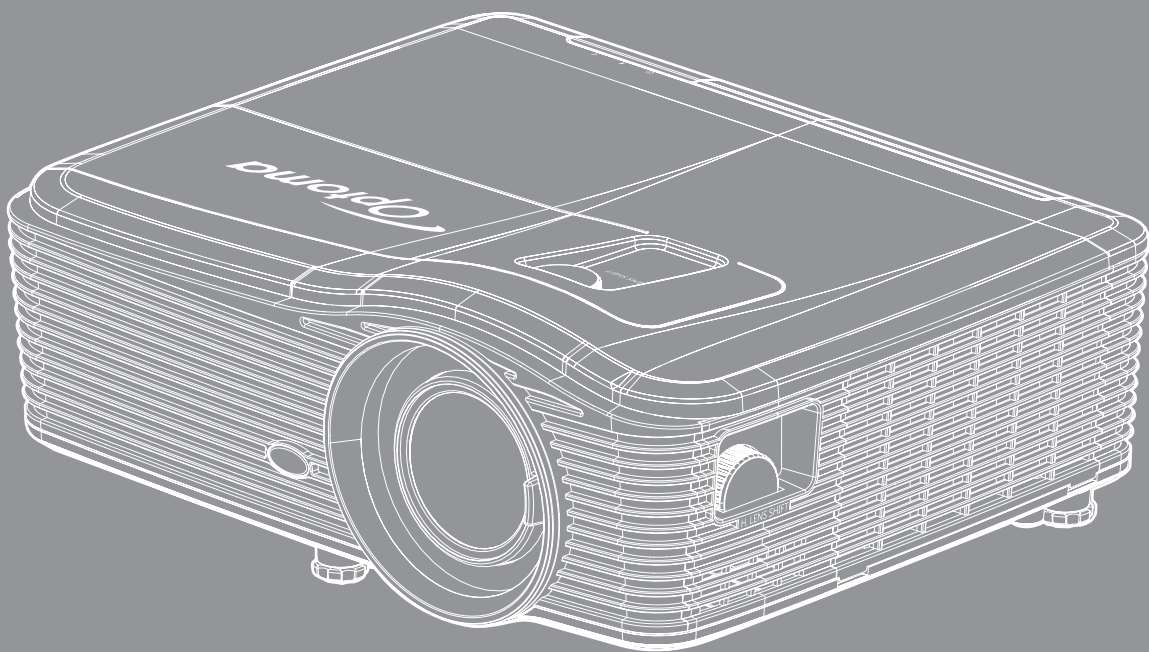

TABLE OF CONTENTS

SAFETY	4
<i>Important Safety Instruction.....</i>	<i>4</i>
<i>3D Safety Information.....</i>	<i>5</i>
<i>Copyright.....</i>	<i>6</i>
<i>Disclaimer.....</i>	<i>6</i>
<i>Trademark Recognition</i>	<i>6</i>
<i>FCC</i>	<i>7</i>
<i>Declaration of Conformity for EU countries</i>	<i>7</i>
<i>WEEE.....</i>	<i>7</i>
INTRODUCTION.....	8
<i>Package Overview.....</i>	<i>8</i>
<i>Standard accessories.....</i>	<i>8</i>
<i>Optional accessories.....</i>	<i>8</i>
<i>Product Overview</i>	<i>9</i>
<i>Connections.....</i>	<i>10</i>
<i>Keypad</i>	<i>11</i>
<i>Remote.....</i>	<i>12</i>
SETUP AND INSTALLATION.....	13
<i>Installing the projector</i>	<i>13</i>
<i>Connecting sources to the projector.....</i>	<i>15</i>
<i>Adjusting the projector image.....</i>	<i>16</i>
<i>Remote setup</i>	<i>17</i>
USING THE PROJECTOR.....	19
<i>Powering on / off the projector.....</i>	<i>19</i>
<i>Selecting an input source</i>	<i>21</i>
<i>Menu navigation and features</i>	<i>22</i>
<i>OSD Menu tree.....</i>	<i>23</i>
<i>Image menu.....</i>	<i>30</i>
<i>Image Advanced menu.....</i>	<i>31</i>
<i>Image advanced signal (RGB) menu</i>	<i>33</i>
<i>Image advanced signal (video) menu.....</i>	<i>34</i>
<i>Display menu.....</i>	<i>34</i>
<i>Display 3D menu</i>	<i>42</i>
<i>Setup menu</i>	<i>43</i>
<i>Setup Security menu</i>	<i>44</i>
<i>Setup Audio Settings menu</i>	<i>45</i>
<i>Setup advanced menu.....</i>	<i>46</i>

<i>Setup network LAN settings menu</i>	47
<i>Setup network control settings menu</i>	49
<i>Setup network control settings menu</i>	50
<i>Options menu</i>	55
<i>Options menu (continued)</i>	56
<i>Options remote settings menu</i>	57
<i>Options advanced menu</i>	58
<i>Options lamp settings menu</i>	60
<i>Options menu</i>	60
<i>Options optional filter settings menu</i>	61
<i>3D Setup</i>	62

MAINTENANCE 63

<i>Replacing the lamp</i>	63
<i>Replacing the lamp (continued)</i>	64
<i>Cleaning the dust filter</i>	65

ADDITIONAL INFORMATION 67

<i>Compatible resolutions</i>	67
<i>Image size and projection distance</i>	69
<i>Determining the lens shift center position</i>	74
<i>Projector dimensions and ceiling mount installation</i>	77
<i>RS232 protocol function list</i>	78
<i>IR remote codes</i>	86
<i>Using the Information button</i>	88
<i>Troubleshooting</i>	89
<i>Warning indicators</i>	90
<i>Specifications</i>	93
<i>Optoma global offices</i>	94

SAFETY

	The lightning flash with arrow head within an equilateral triangle is intended to alert the user to the presence of uninsulated "dangerous voltage" within the product's enclosure that may be of sufficient magnitude to constitute a risk of electric shock to persons.
	The exclamation point within an equilateral triangle is intended to alert the user to the presence of important operating and maintenance (servicing) instructions in the literature accompanying the appliance.

Please follow all warnings, precautions and maintenance as recommended in this user's guide.

Important Safety Instruction

- Do not block any ventilation openings. To ensure reliable operation of the projector and to protect from over heating, it is recommended to install the projector in a location that does not block ventilation. As an example, do not place the projector on a crowded coffee table, sofa, bed, etc. Do not put the projector in an enclosure such as a book case or a cabinet that restricts air flow.
- To reduce the risk of fire and/or electric shock, do not expose the projector to rain or moisture. Do not install near heat sources such as radiators, heaters, stoves or any other apparatus such as amplifiers that emits heat.
- Do not let objects or liquids enter the projector. They may touch dangerous voltage points and short out parts that could result in fire or electric shock.
- Do not use under the following conditions:
 - In extremely hot, cold or humid environments.
 - (i) Ensure that the ambient room temperature is within 5°C ~ 40°C
 - (ii) Relative humidity is 10% ~ 85%
 - In areas susceptible to excessive dust and dirt.
 - Near any appliance generating a strong magnetic field.
 - In direct sunlight.
- Do not use the projector in places where flammable gases or explosives gases may be present in the atmosphere. The lamp inside the projector becomes very hot during operation and the gases may ignite and result in a fire.
- Do not use lens cap when projector is in operation.
- Do not use the unit if it has been physically damaged or abused. Physical damage/abuse would be (but not limited to):
 - Unit has been dropped.
 - Power supply cord or plug has been damaged.
 - Liquid has been spilled on to the projector.
 - Projector has been exposed to rain or moisture.
 - Something has fallen in the projector or something is loose inside.
- Do not place the projector on an unstable surface. The projector may fall over resulting in injury or the projector may become damaged.
- Do not block the light coming out of the projector lens when in operation. The light will heat the object and could melt, cause burns or start a fire.
- Please do not open or disassemble the projector as this may cause electric shock.
- Do not attempt to service the unit yourself. Opening or removing covers may expose you to dangerous voltages or other hazards. Please call Optoma before you send the unit for repair.
- See projector enclosure for safety related markings.

- The unit should only be repaired by appropriate service personnel.
- Only use attachments/accessories specified by the manufacturer.
- Do not look into straight into the projector lens during operation. The bright light may harm your eyes.
- When replacing the lamp, please allow the unit to cool down. Follow instructions as described on pages 63-64.
- This projector will detect the life of the lamp itself. Please be sure to change the lamp when it shows warning messages.
- Reset the "Lamp Reset" function from the on-screen display "Options > Lamp Settings" menu after replacing the lamp module (refer to page 60).
- When switching the projector off, please ensure the cooling cycle has been completed before disconnecting power. Allow 90 seconds for the projector to cool down.
- When the lamp is approaching to the end of its life time, the message "Lamp life exceeded." will show on the screen. Please contact your local reseller or service center to change the lamp as soon as possible.
- Turn off and unplug the power plug from the AC outlet before cleaning the product.
- Use a soft dry cloth with mild detergent to clean the display housing. Do not use abrasive cleaners, waxes or solvents to clean the unit.
- Disconnect the power plug from AC outlet if the product is not being used for a long period of time.

Note: *When the lamp reaches the end of its life, the projector will not turn back on until the lamp module has been replaced. To replace the lamp, follow the procedures listed under "Replacing the Lamp" section on pages 63-64.*

- *Do not setup the projector in places where it might be subjected to vibration or shock.*
- *Do not touch the lens with bare hands*
- *Remove battery/batteries from remote control before storage. If the battery/batteries are left in the remote for long periods, they may leak.*
- *Do not use or store the projector in places where smoke from oil or cigarettes may be present, as it can adversely affect the quality of the projector performance.*
- *Please follow the correct projector orientation installation as non standard installation may affect the projector performance.*

3D Safety Information

Please follow all warnings and precautions as recommended before you or your child use the 3D function.

Warning

Children and teenagers may be more susceptible to health issues associated with viewing in 3D and should be closely supervised when viewing these images.

Photosensitive Seizure Warning and Other Health Risks

- Some viewers may experience an epileptic seizure or stroke when exposed to certain flashing images or lights contained in certain Projector pictures or video games. If you suffer from, or have a family history of epilepsy or strokes, please consult with a medical specialist before using the 3D function.
- Even those without a personal or family history of epilepsy or stroke may have an undiagnosed condition that can cause photosensitive epileptic seizures.
- Pregnant women, the elderly, sufferers of serious medical conditions, those who are sleep deprived or under the influence of alcohol should avoid utilizing the unit's 3D functionality.
- If you experience any of the following symptoms, stop viewing 3D pictures immediately and consult a medical specialist: (1) altered vision; (2) light-headedness; (3) dizziness; (4) involuntary movements such as eye or muscle twitching; (5) confusion; (6) nausea; (7) loss of awareness; (8) convulsions; (9) cramps; and/ or (10) disorientation. Children and teenagers may be more likely than adults to experience these symptoms. Parents should monitor their children and ask whether they are

experiencing these symptoms.

- Watching 3D projection may also cause motion sickness, perceptual after effects, disorientation, eye strain and decreased postural stability. It is recommended that users take frequent breaks to lessen the potential of these effects. If your eyes show signs of fatigue or dryness or if you have any of the above symptoms, immediately discontinue use of this device and do not resume using it for at least thirty minutes after the symptoms have subsided.
- Watching 3D projection while sitting too close to the screen for an extended period of time may damage your eyesight. The ideal viewing distance should be at least three times the screen height. It is recommended that the viewer's eyes are level with the screen.
- Watching 3D projection while wearing 3D glasses for an extended period of time may cause a headache or fatigue. If you experience a headache, fatigue or dizziness, stop viewing the 3D projection and rest.
- Do not use the 3D glasses for any other purpose than for watching 3D projection.
- Wearing the 3D glasses for any other purpose (as general spectacles, sunglasses, protective goggles, etc.) may be physically harmful to you and may weaken your eyesight.
- Viewing in 3D projection may cause disorientation for some viewers. Accordingly, DO NOT place your 3D PROJECTOR near open stairwells, cables, balconies, or other objects that can be tripped over, run into, knocked down, broken or fallen over.

Copyright

This publication, including all photographs, illustrations and software, is protected under international copyright laws, with all rights reserved. Neither this manual, nor any of the material contained herein, may be reproduced without written consent of the author.

© Copyright 2017

Disclaimer

The information in this document is subject to change without notice. The manufacturer makes no representations or warranties with respect to the contents hereof and specifically disclaims any implied warranties of merchantability or fitness for any particular purpose. The manufacturer reserves the right to revise this publication and to make changes from time to time in the content hereof without obligation of the manufacturer to notify any person of such revision or changes.

Trademark Recognition

Kensington is a U.S. registered trademark of ACCO Brand Corporation with issued registrations and pending applications in other countries throughout the world.

HDMI, the HDMI Logo, and High-Definition Multimedia Interface are trademarks or registered trademarks of HDMI Licensing LLC in the United States and other countries.

IBM is a trademark or registered trademark of International Business Machines, Inc. Microsoft, PowerPoint, and Windows are trademarks or registered trademarks of Microsoft Corporation.

Adobe and Acrobat are trademarks or registered trademarks of Adobe Systems Incorporated.

DLP®, DLP Link and the DLP logo are registered trademarks of Texas Instruments and BrilliantColor™ is a trademark of Texas Instruments.

All other product names used in this manual are the properties of their respective owners and are Acknowledged.

FCC

This device has been tested and found to comply with the limits for a Class B digital device pursuant to Part 15 of the FCC rules. These limits are designed to provide reasonable protection against harmful interference in a residential installation. This device generates, uses and can radiate radio frequency energy and, if not installed and used in accordance with the instructions, may cause harmful interference to radio communications.

However, there is no guarantee that interference will not occur in a particular installation. If this device does cause harmful interference to radio or television reception, which can be determined by turning the device off and on is encouraged to try to correct the interference by one or more of the following measures:

- Reorient or relocate the receiving antenna.
- Increase the separation between the device and receiver.
- Connect the device into an outlet on a circuit different from that to which the receiver is connected.
- Consult the dealer or an experienced radio/television technician for help.

Notice: Shielded cables

All connections to other computing devices must be made using shielded cables to maintain compliance with FCC regulations.

Caution

Changes or modifications not expressly approved by the manufacturer could void the user's authority, which is granted by the Federal Communications Commission, to operate this projector.

Operation Conditions

This device complies with Part 15 of the FCC Rules. Operation is subject to the following two conditions:

1. This device may not cause harmful interference and
2. This device must accept any interference received, including interference that may cause undesired operation.

Notice: Canadian users

This Class B digital apparatus complies with Canadian ICES-003.

Remarque à l'intention des utilisateurs canadiens

Cet appareil numérique de la classe B est conforme à la norme NMB-003 du Canada.

Declaration of Conformity for EU countries

- EMC Directive 2014/30/EC (including amendments)
- Low Voltage Directive 2014/35/EC
- R & TTE Directive 1999/5/EC (if product has RF function)

WEEE



Disposal instructions

Do not throw this electronic device into the trash when discarding. To minimize pollution and ensure utmost protection of the global environment, please recycle it.

INTRODUCTION

Package Overview

Carefully unpack and verify that you have the items listed below under standard accessories. Some of the items under optional accessories may not be available depending on the model, specification and your region of purchase. Please check with your place of purchase. Some accessories may vary from region to region.

The warranty card is only supplied in some specific regions. Please consult your dealer for detailed information.

Standard accessories

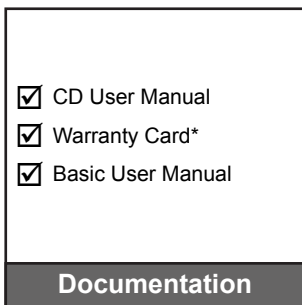
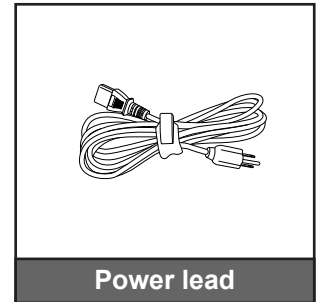
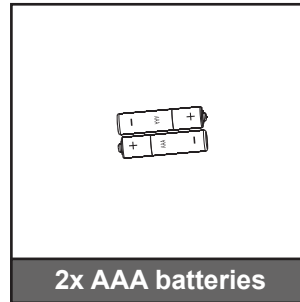
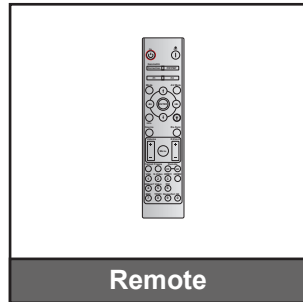
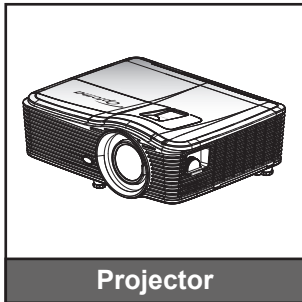

Note: * For European warranty Information, please visit www.optomaeurope.com.

Optional accessories

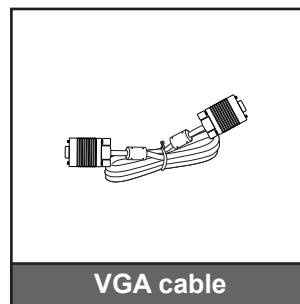
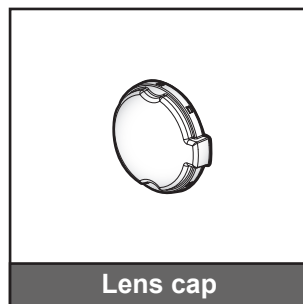

Note: Optional accessories vary depending on model, specification and region.

INTRODUCTION

Product Overview

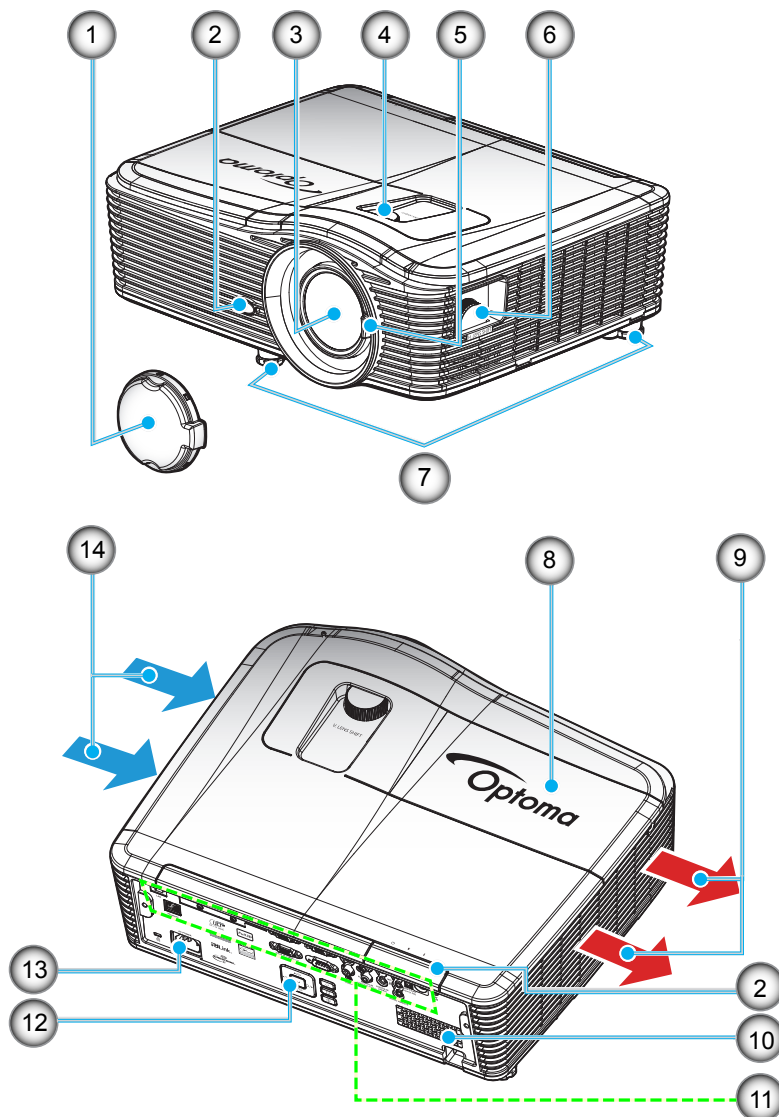

Note: Do not block projector inlet or outlet air vents.

(*) optional accessory vary depending on model, specification and region.

No	Item	No	Item
1.	Lens Cap (*)	8.	Lamp Cover
2.	IR Receiver	9.	Ventilation (outlet)
3.	Lens	10.	Speaker
4.	Lens Shift (vertical)	11.	Input/Output Connections
5.	Focus Lever	12.	Keypad
6.	Lens Shift (horizontal)	13.	Power Socket
7.	Tilt-Adjustment Feet	14.	Ventilation (inlet)

INTRODUCTION

Connections

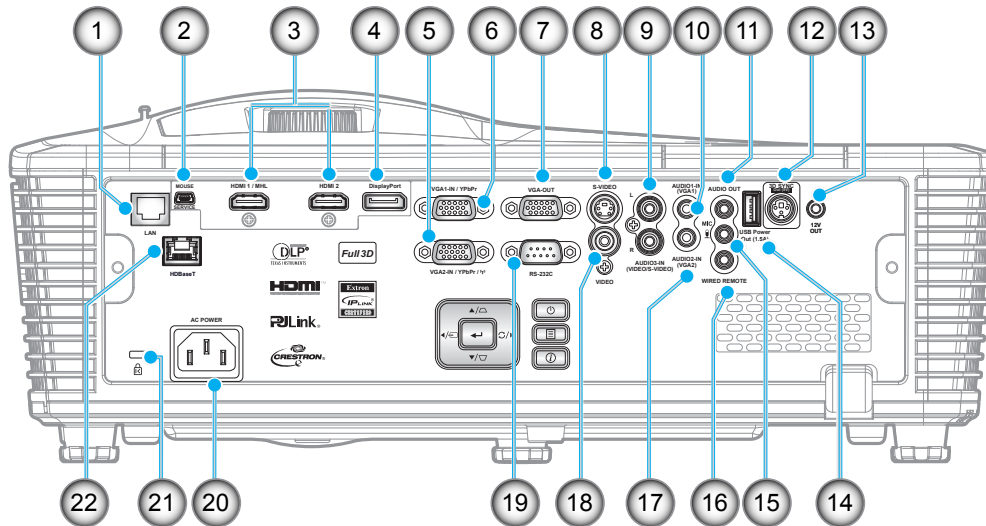

No	Item	No	Item
1.	RJ-45 connector	12.	3D SYNC OUT (5V) connector
2.	USB-B mini connector (Fireware upgrade)	13.	12V OUT connector
3.	1 x HDMI and 1 x HDMI/MHL Connector	14.	USB Power Out (1.5A) connector
4.	DisplayPort connector	15.	Microphone connector
5.	VGA2-IN/YPbPr / (Y ^P) connector	16.	WIRED REMOTE connector
6.	VGA1-IN / YPbPr connector	17.	AUDIO2-In (VGA2) connector
7.	VGA-OUT connector	18.	VIDEO connector
8.	S-VIDEO connector	19.	RS-232C connector
9.	AUDIO3-IN (Video/S-Video) connector	20.	Power socket
10.	AUDIO1-IN(VGA1) connector	21.	Kensington™ lock port
11.	AUDIO OUT connector	22.	HDBaseT connector (*)

Note:

- Remote mouse requires special remote.
- (*)On models with HDBaseT only.

INTRODUCTION

Keypad

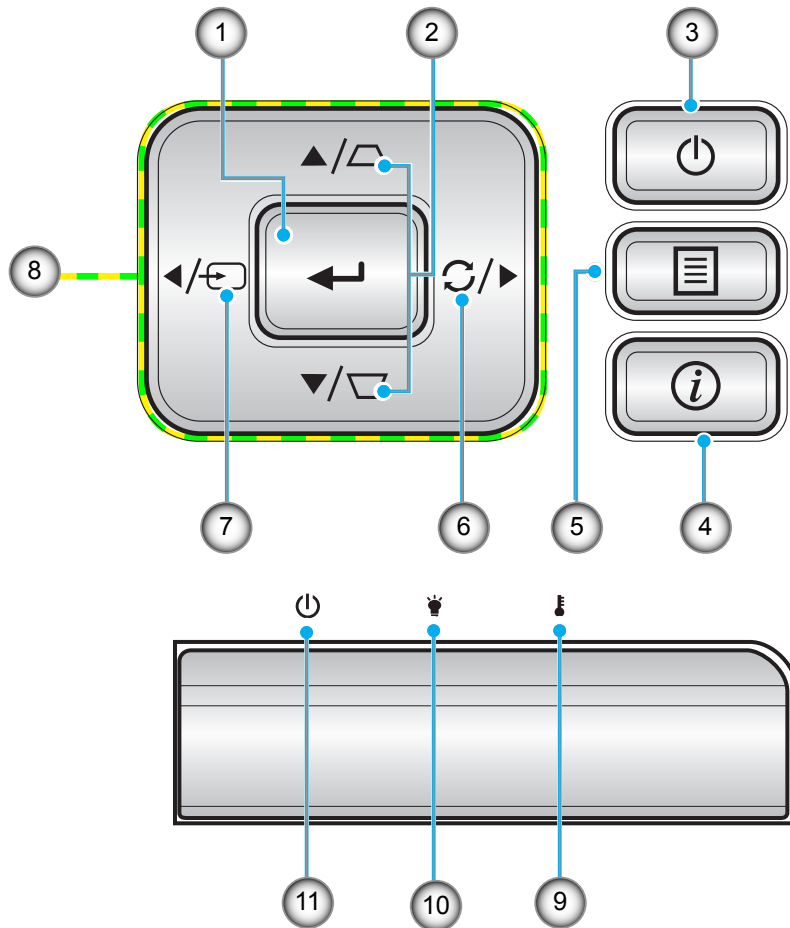

No	Item	No	Item
1.	Enter	7.	Source
2.	Keystone Correction	8.	Four Directional Select Keys
3.	Power	9.	Temp LED
4.	Information	10.	Lamp LED
5.	Menu	11.	On/Standby LED
6.	Re-Sync		

INTRODUCTION

Remote

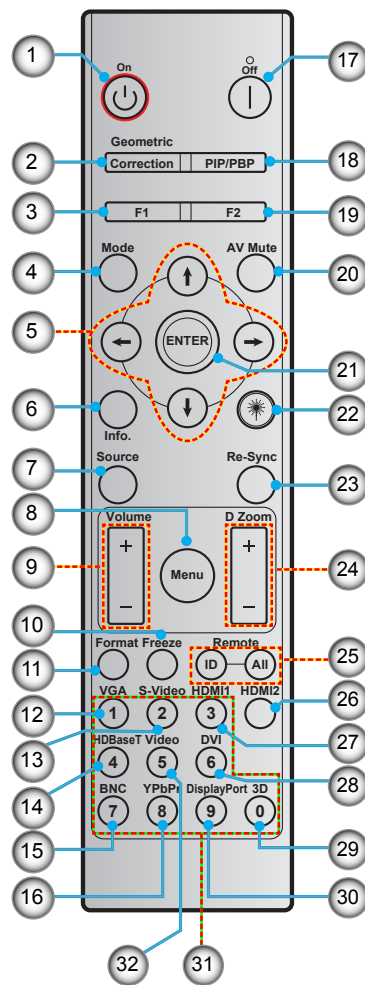

No	Item	No	Item
1.	Power on	17.	Power off
2.	Geometric Correction	18.	PIP/PBP
3.	Function button (F1) (Assignable)	19.	Function button (F2) (Assignable)
4.	Mode	20.	AV mute
5.	Four directional select keys	21.	Enter
6.	Information	22.	Laser
7.	Source	23.	Re-sync
8.	Menu	24.	D Zoom (Digital Zoom)
9.	Volume - / +	25.	Remote ID / Remote All
10.	Freeze	26.	HDMI2
11.	Format (Aspect Ratio)	27.	HDMI1
12.	VGA	28.	DVI
13.	S-Video	29.	3D
14.	HDBaseT	30.	DisplayPort
15.	BNC	31.	Numeric keypad (0-9)
16.	YPbPr	32.	Video

Note: Some keys may have no function for models that do not support these features.

SETUP AND INSTALLATION

Installing the projector

Your projector is designed to be installed in one of four possible positions.

Your room layout or personal preference will dictate which installation location you select. Take in to consideration the size and position of your screen, the location of a suitable power outlet, as well as the location and distance between the projector and the rest of your equipment.

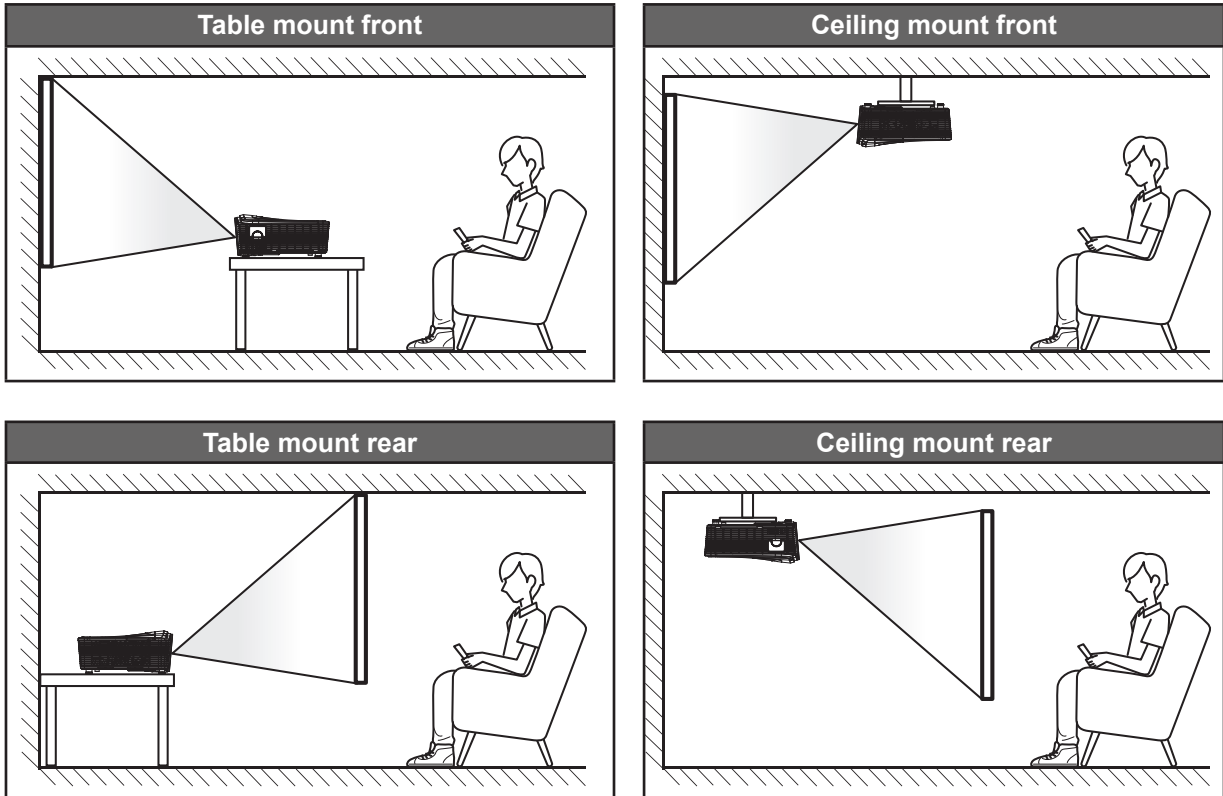

Projector should be placed flat on a surface and 90 degrees / perpendicular to the to the screen.

- How to determine projector location for a given screen size, please refer to distance table on pages 69-73.
- How to determine screen size for a given distance, please refer to distance table on pages 69-73.

Note: *The further away the projector is placed from the screen the projected image size increases and vertical offset also increases proportionally.*

SETUP AND INSTALLATION

Projector installation notice

- Place the projector in a horizontal position.
The tilt angle of the projector should not exceed 15 degrees, nor should the projector be installed in any way other than the desktop and ceiling mount, otherwise lamp life could decrease dramatically, and may lead to other **unpredictable damages**.

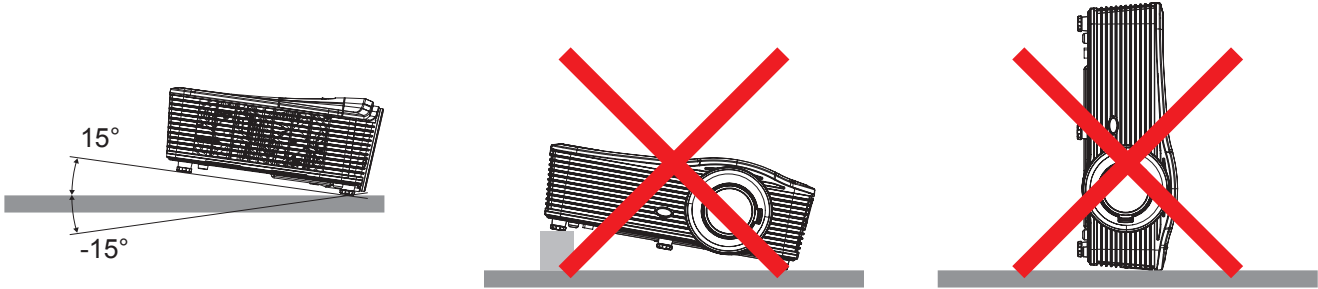

- Allow at least 50 cm clearance around the exhaust vent.

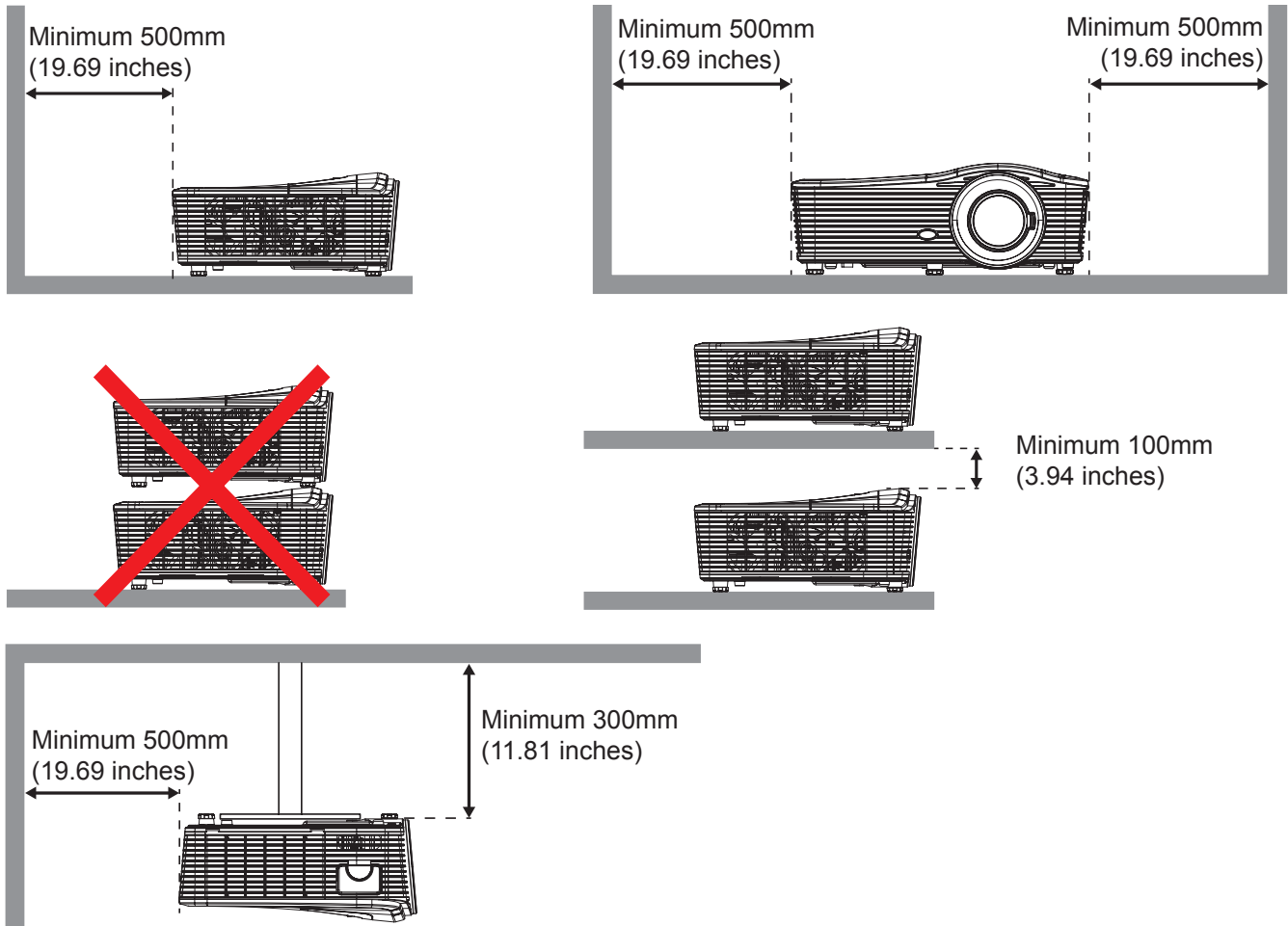

- Ensure that the intake vents do not recycle hot air from the exhaust vent.
- When operating the projector in an enclosed space, ensure that the surrounding air temperature within the enclosure does not exceed operation temperature while the projector is running, and the air intake and exhaust vents are unobstructed.
- All enclosures should pass a certified thermal evaluation to ensure that the projector does not recycle exhaust air, as this may cause the device to shutdown even if the enclosure temperature is within the acceptable operation temperature range.

SETUP AND INSTALLATION

Connecting sources to the projector

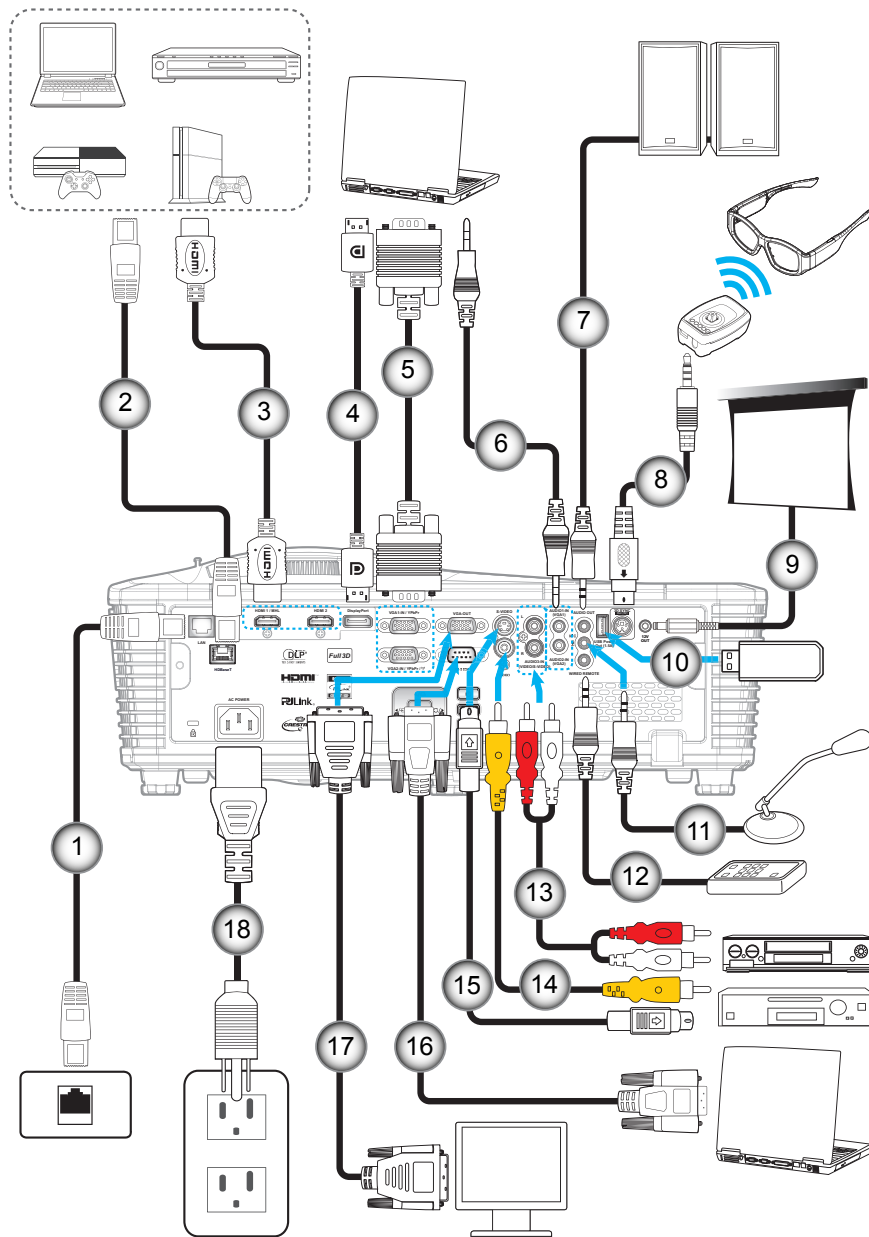

No	Item	No	Item
1.	RJ-45 cable	10.	USB dongle / USB Power Charger
2.	RJ-45 cable (Cat5 cable)	11.	Microphone cable
3.	HDMI / MHL cable	12.	Wired Remote Control cable
4.	DisplayPort cable	13.	Audio In cable
5.	VGA cable	14.	Video cable
6.	Audio In cable	15.	S-Video cable
7.	Audio Out cable	16.	RS232 cable
8.	3D emitter cable	17.	VGA Out cable
9.	12V DC Jack	18.	Power cord

SETUP AND INSTALLATION

Adjusting the projector image

Image height

The projector is equipped with elevator feet for adjusting the image height.

1. Locate the adjustable foot you wish to adjust on the underside of the projector.
2. Rotate the adjustable foot clockwise or anticlockwise to raise or lower the projector.

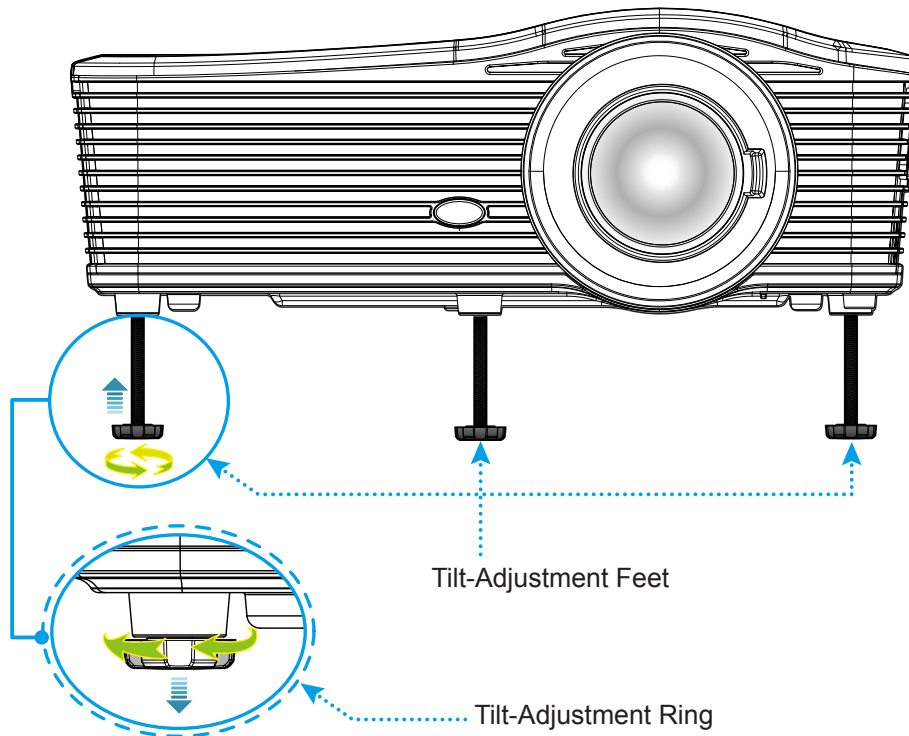

Focus

To adjust the focus, turn the focus lever clockwise or anticlockwise until the image is sharp and legible.

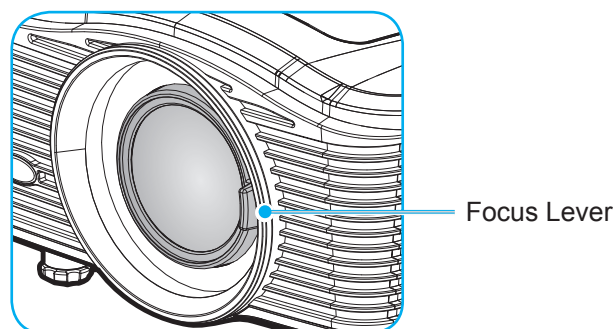

Note: The projector will focus at a distance as follows:

- XGA: 19.7" ~ 196.9" (0.5 ~ 5.0m)
- WXGA: 19.7" ~ 212.6" (0.5 ~ 5.4m)
- 1080P: 19.7" ~ 208.7" (0.5 ~ 5.3m)
- WUXGA: 19.7" ~ 204.7" (0.5 ~ 5.2m)

SETUP AND INSTALLATION

Remote setup

Installing / replacing the batteries

Two AAA size batteries are supplied for the remote control.

1. Remove the battery cover on the back of the remote.
2. Insert AAA batteries as illustrated.
3. Replace back cover on remote.

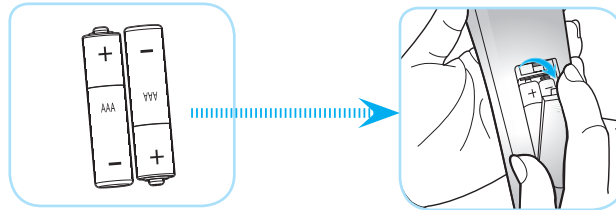

Note: Replace only with the same or equivalent type batteries.

CAUTION

Improper use of batteries can result in chemical leakage or explosion. Be sure to follow the instructions below.

- Do not mix batteries of different types. Different types of batteries have different characteristics.
- Do not mix old and new batteries. Mixing old and new batteries can shorten the life of new batteries or cause chemical leakage in old batteries.
- Remove batteries as soon as they are depleted. Chemicals that leak from batteries that come in contact with skin can cause a rash. If you find any chemical leakage, wipe thoroughly with a cloth.
- The batteries supplied with this product may have a shorter life expectancy due to storage conditions.
- If you will not be using the remote control for an extended period of time, remove the batteries.
- When you dispose of the batteries, you must obey the law in the relative area or country.

Effective range

Infra-Red (IR) remote control sensor is located on the rear side of the projector. Ensure to hold the remote control at an angle within 30 degrees perpendicular to the projector's IR remote control sensors to function correctly. The distance between the remote control and the sensor should not be longer than 7 meters (~ 23 feet).

- Make sure that there are no obstacles between the remote control and the IR sensor on the projector that might obstruct the infra-red beam.
- Make sure the IR transmitter of the remote control is not being shined by sunlight or fluorescent lamps directly.
- Please keep the remote controller away from fluorescent lamps for over 2 m or the remote controller might become malfunction.
- If the remote control is close to Inverter-Type fluorescent lamps, it might become ineffective from time to time.
- If the remote control and the projector are within a very short distance, the remote control might become ineffective.
- When you aim at the screen, the effective distance is less than 5 m from the remote control to the screen and reflecting the IR beams back to the projector. However, the effective range might change according to screens.

SETUP AND INSTALLATION

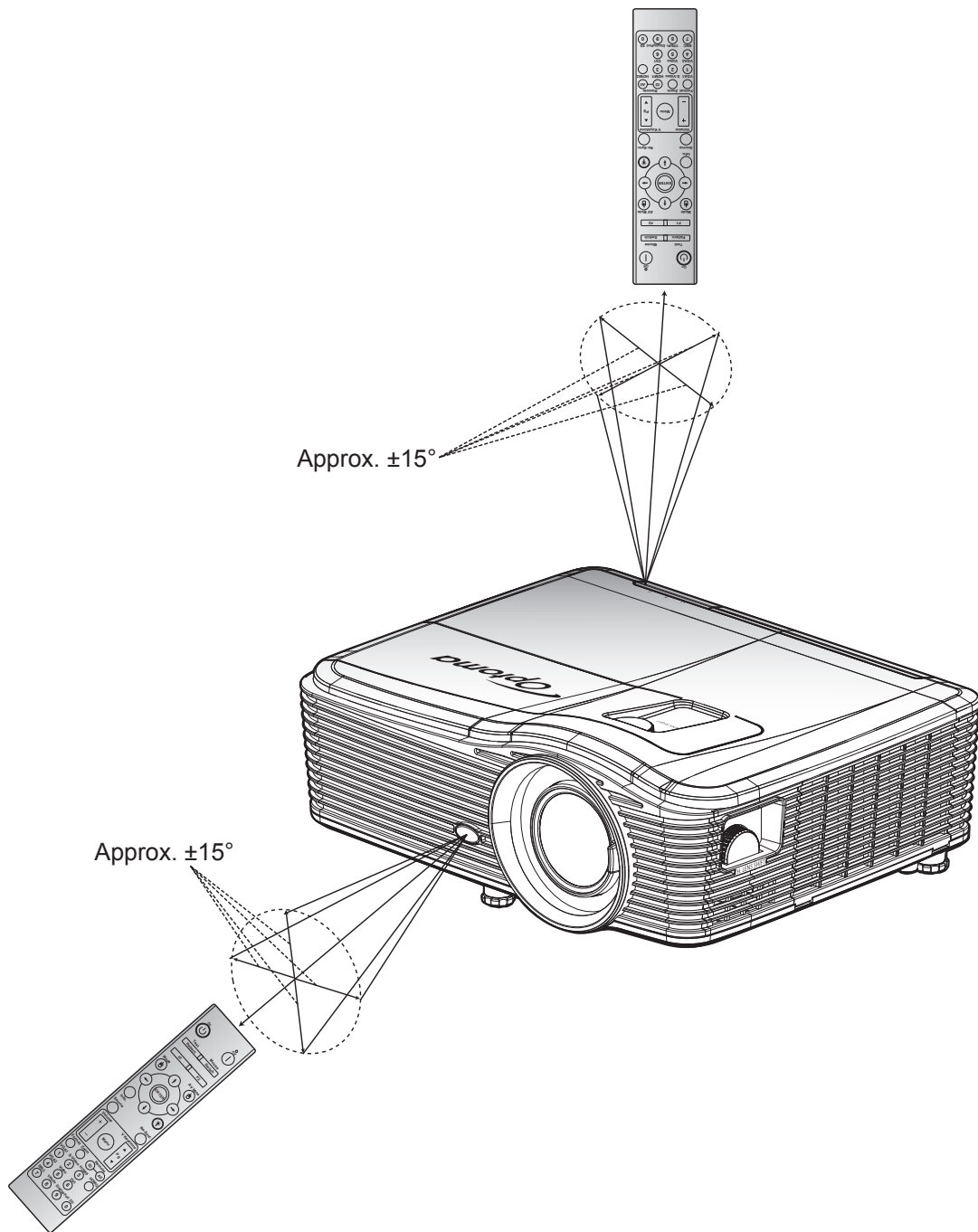

USING THE PROJECTOR

Powering on / off the projector

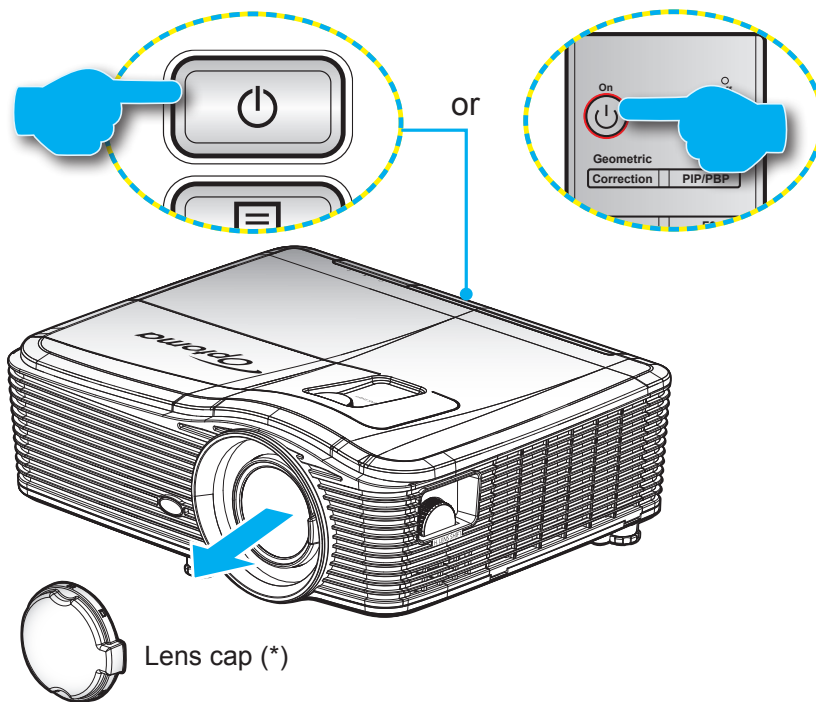

Powering on

1. Remove the lens cap(*).
2. Securely connect the power lead and signal/source cable. When connected, the On/Standby LED will turn amber.
3. Turn on the projector by pressing the "⏻" either on the projector keypad or the remote control
4. A start up screen will display in approximately 10 seconds and the On/Standby LED will be solid red.

Note: The first time the projector is turned on you will be asked to select the preferred language, projection orientation and a few other settings.

USING THE PROJECTOR

Powering off

1. Turn off the projector by pressing the "⏻" either on the projector keypad or the remote control.
2. The following message will be displayed:

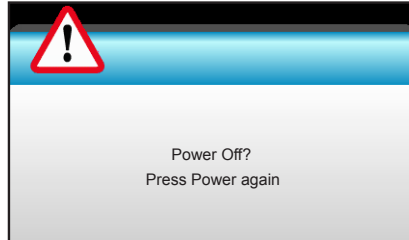

3. Press the "⏻" again to confirm otherwise the message will disappear after 15 seconds. When you press the "⏻" button for the second time the projector will shut down.
4. The cooling fans will continue to operate for about 10 seconds for the cooling cycle and the On/Standby LED will flash blue. When the On/Standby LED turns solid red the projector has entered standby mode. If you wish to turn the projector back on, you must wait until the cooling cycle has finished and the projector has entered standby mode. When the projector is in standby mode simply press the "⏻" button again to turn on the projector.
5. Disconnect the power lead from the electrical outlet and the projector.

Note: (*) *Optional accessory vary depending on model, specification and region.
It is not recommended that the projector is tuned on immediately following a power off procedure.*

USING THE PROJECTOR

Selecting an input source

Turn on the connected source that you want to display on the screen (computer, notebook, video player, etc.). The projector will automatically detect the source. If multiple sources are connected, push the source button on the projector keypad or remote to select the desired input.

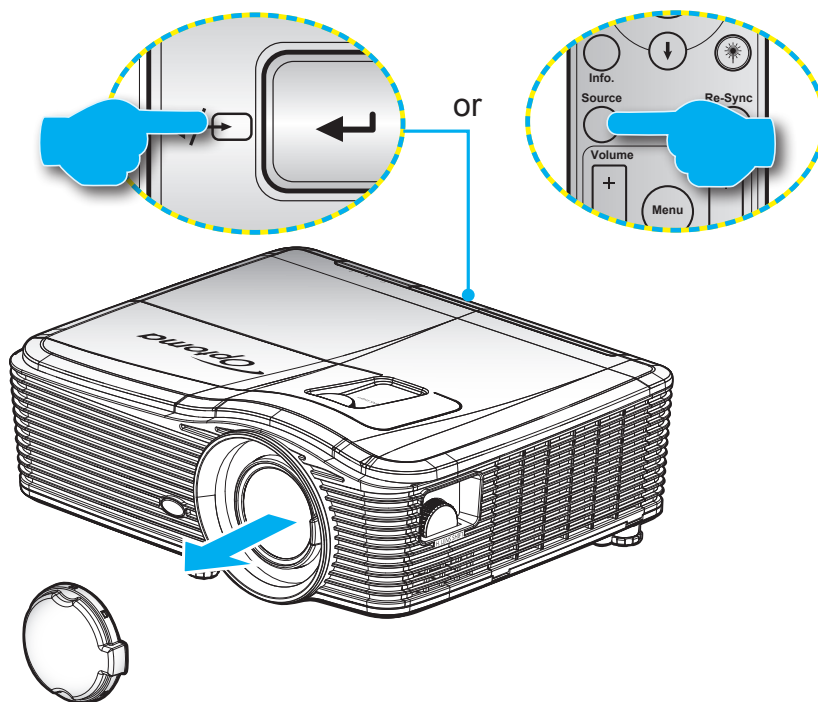

USING THE PROJECTOR

Menu navigation and features

The projector has multilingual on-screen display menus that allow you to make image adjustments and change a variety of settings. The projector will automatically detect the source.

1. To open the OSD menu, press "Menu" on the Remote Control or Keypad.
2. When OSD is displayed, use ◀▶ keys to select any item in the main menu. While making a selection on a particular page, press ▼ or "Enter" key to enter sub menu.
3. Use ▲▼ keys to select the desired item in the sub menu and then press ▶ or "Enter" key to view further settings. Adjust the settings by ◀▶ key.
4. Select the next item to be adjusted in the sub menu and adjust as described above.
5. Press "Enter" or "Menu" to confirm, and the screen will return to the main menu.
6. To exit, press "Menu" again. The OSD menu will close and the projector will automatically save the new settings.

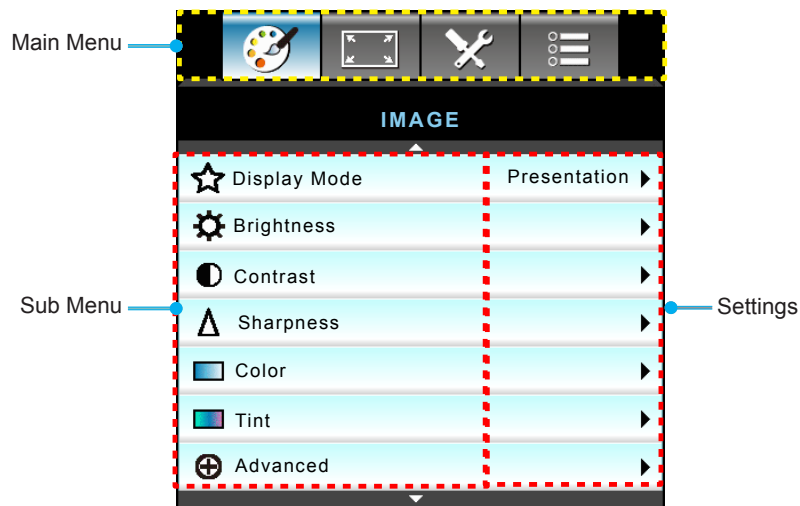

USING THE PROJECTOR

OSD Menu tree

Main menu	Sub menu	Advanced menu	Single-item menu	Value	
Image	Display Mode		Presentation	Default [Presentation] PS. Each mode can adjust and save in each mode	
			Bright		
			Movie		
			sRGB		
			Blackboard		
			DICOM SIM.		
			User		
			3D		
	Brightness			-50~50	
	Contrast			-50~50	
	Sharpness			1 ~15	
	Color			-50~50	
	Tint			-50~50	
	Advanced		BrilliantColor™		1~10
			Gamma	Film	
				Graphics	
				1.8	
				2.0	
				2.2	
				2.6	
				Blackboard	
				DICOM	
			Color Temp.	Warm	
				Standard	
				Cool	
				Cold	
			Color Space	Not HDMI Input: Auto / RGB / YUV	
				HDMI Input: Auto/ RGB(0~255) / RGB(16~235)/ YUV	
			RGB Gain/Bias	Red Gain	-50~50
				Green Gain	-50~50
				Blue Gain	-50~50
				Red Bias	-50~50
				Green Bias	-50~50
Blue Bias	-50~50				
Reset					
Exit					







USING THE PROJECTOR

Main menu	Sub menu	Advanced menu	Single-item menu	Value		
Image	Advanced	Color Matching	Red	Hue/Saturation/Gain [-50~50]		
			Green	Hue/Saturation/Gain [-50~50]		
			Blue	Hue/Saturation/Gain [-50~50]		
			Cyan	Hue/Saturation/Gain [-50~50]		
			Magenta	Hue/Saturation/Gain [-50~50]		
			Yellow	Hue/Saturation/Gain [-50~50]		
			White	Red/Green/Blue		
			Reset			
			Exit			
		Signal (RGB)	Automatic	On Off		
			Phase	0~31		
			Frequency	-10~10		
			H. Position	-5~5		
			V. Position	-5~5		
			Exit			
		Signal (Video)	White Level	0~31		
			Black Level	-5~5		
			IRE	0/7.5 (NTSC only)		
			Exit			
		Exit				
		Reset				
		Display	Format		XGA: 4:3, 16:9 Native, Auto	
					1080p: 4:3, 16:9, LBX, Native, Auto	
	WUXGA: 4:3, 16:9 or 16:10, Native, Auto					
Zoom				-5~25		
Edge Mask				0~10		
Image Shift	H		Right/Left (Icon in center)	-100~100		
	V		Up/Down (Icon in center)	-100 ~ 100		
Geometric Correction	H. Keystone			-30 ~ 30		
	V. Keystone			-30 ~ 30		
	Auto V. Keystone		On	Default [Off]		
			Off			
	Four Corners		Top-Left			
Top-Right						
Bottom-Left						

USING THE PROJECTOR

Main menu	Sub menu	Advanced menu	Single-item menu	Value	
Display	Geometric Correction	Four Corners	Bottom-Right (ICONS)		
		Reset			
	3D	3D Mode		DLP-Link	
				VESA 3D	
				Off	
		3D->2D		3D	
				L	
			R		
		3D Format		Auto	
				SBS	
				Top and Bottom	
				Frame Sequential	
	3D Sync Invert		On		
			Off		
		Exit			
	Setup	Language		English	
				Deutsch	
			Français		
			Italiano		
			Español		
			Português		
			Svenska		
			Nederlands		
			Norsk/Dansk		
			Polski		
			Русский		
			Suomi		
			Ελληνικά		
			Magyar		
			Čeština		
			عربي		
			繁體中文		
			簡體中文		
			日本語		
			한국어		
			ไทย		
			Türkçe		
			Farsi		
	Tiếng Việt				
	Română				
	Bahasa Indonesia				
	Slovakian				

USING THE PROJECTOR

Main menu	Sub menu	Advanced menu	Single-item menu	Value	
Setup	Projection		Front 		
			Rear 		
			Front-Ceiling 		
			Rear-Ceiling 		
	Screen Type			16:10	
				16:9	
				WXGA	
				WUXGA	
	Menu Location			Top Left 	
				Top Right 	
				Center 	
				Bottom Left 	
				Bottom Right 	
	Security	Security		On	
				Off	
		Security Timer		Month	
				Day	
				Hour	
			Change Password		
		Exit			
	Projector ID				00~99
	Audio Settings	Internal Speaker		On	
				Off	
		Mute		On	
				Off	
		Volume		Audio	0~10
				Mic	0~10
		Audio Input		Default	- Audio 3-> L/R
				Audio1	- Audio 1, 2->mini jack
				Audio2	Default: -VGA1->Audio 1 -VGA2->Audio 2 -Video, S-video ->Audio 3
		Audio Out(Standby)		On	
			Off	Default[Off]	
		Exit			
	Advanced	Logo		Default	
				Neutral	
				User	
		Logo Capture			
		Closed Captioning		Off	
				CC1	
				CC2	
		Wireless		On	Only support non-HDBaseT model via VGA2
				Off	
		Exit			

USING THE PROJECTOR

Main menu	Sub menu	Advanced menu	Single-item menu	Value
Models with HDBaseT	HDBaseT Control	Ethernet	On	Default[Off]
			Off	
		RS232	On	Default[Off]
			Off	
Setup	Network	LAN Settings	Network Status	Connect/Disconnect(Read-Only)
			DHCP	On
				Off [Default Off]
			IP Address	Default [192.168.0.100]
			Subnet Mask	Default [255.255.255.0]
			Gateway	Default [192.168.0.254]
			DNS	Default [192.168.0.1]
			MAC Address	Read-Only
		Exit		
		Control Settings	Crestron	On / Off (port:41794)
			Extron	On / Off (port: 2023)
			PJ Link	On / Off (port: 4352)
			AMX Device Discovery	On / Off (port: 9131)
			Telnet	On / Off (port: 23)
			HTTP	On / Off (port: 80)
			Exit	
		Reset		
Options	Input Source		VGA1	PS. HDBaseT only exists in models with HDBaseT.
			VGA2	
			Video	
			S-Video	
			HDMI1	
			HDMI2	
			Displayport	
			HDBaseT	
		Exit		
	Source Lock		On	[Default On] HDMI1 / HDMI2/ VGA1 / VGA2 / Video / S-Video/ DisplayPort/ HDBaseT
			Off	
	High Altitude		On	[Default Off]
			Off	
	Information Hide		On	[Default Off]
			Off	
	Keypad Lock		On	[Default Off]
			Off	
	Display Mode Lock		On	[Default Off]
			Off	
	Test Pattern		None	
			Grid	
			White Pattern	

USING THE PROJECTOR

Main menu	Sub menu	Advanced menu	Single-item menu	Value	
Options	Background Color		Black	[Default Blue]	
			Red		
			Blue		
			Green		
			White		
	Wall Color			Off	
				Light Yellow	
				Light Green	
				Light Blue	
				Pink	
				Gray	
	Remote Settings	F1		HDMI2	[Default "Test Pattern"] For models with HDBaseT, the default value is "HDBaseT".
				DP	
				VGA2	
				S-Video	
				Test Pattern	
				Zoom	
				Info.	
				Format	
		F2		HDMI2	[Default "Zoom"] For models with HDBaseT, the default value is "HDBaseT".
				DP	
				VGA2	
				S-Video	
				Test Pattern	
				Zoom	
				Info.	
				Format	
		F3		HDMI2	[Default "Info"] For models with HDBaseT, the default value is "HDBaseT".
				DP	
				VGA2	
				S-Video	
				Test Pattern	
			Zoom		
			Info.		
			Format		
IR Function				On	
				Front	
				Top	
			Off		
Remote Code			00~99	[Default 00]	
			Exit		
12V Trigger			On	[Default On]	
			Off		
Beep			On	[Default On]	
			Off		

USING THE PROJECTOR

Main menu	Sub menu	Advanced menu	Single-item menu	Value
Options	Advanced	Direct Power On	On	[Default Off]
			Off	
		Signal Power On*	On	[Default Off]
			Off	
		Auto Power Off (min.)		0-180 (one step: 5 mins)
		Sleep Timer (min.)		0-990 (one step: 10 mins)
				Always On [check box style, default is unchecked.]
	Power Mode (Standby)	Active		
		Eco		
	Exit			
	Lamp Settings	Lamp Hour		
		Lamp Reminder	On	[Default Off]
			Off	
		Lamp Mode	Bright	
			Eco	
			Power	
		Power	100%	
			95%	
			90%	
			85%	
	80%			
	Lamp Reset	Yes		
		No		
	Exit			
	Optional Filter Settings	Optional Filter Installed		Yes
				No
		Filter Usage Hours		Read-Only [Range 0~ 9999]
		Filter Reminder		Off
				300 hr
				500 hr [Default]
				800 hr
				1000 hr
Filter Reset		Yes		
		No		
Exit				
Information				
Reset		Yes		
		No		

Note: (*) Optional feature depending on model and region.

USING THE PROJECTOR

Image menu

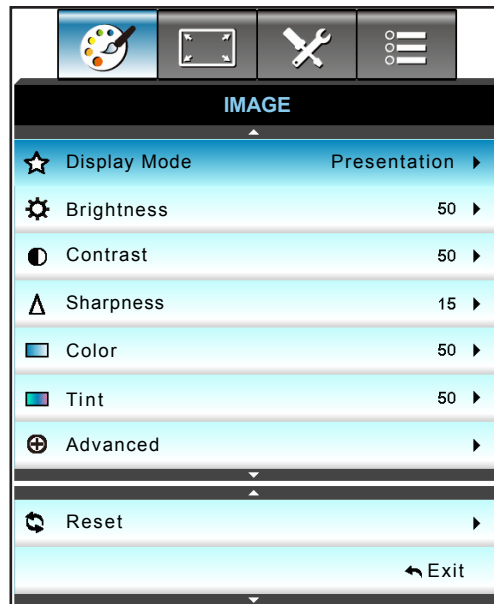

Display Mode

There are many factory presets optimized for various types of images.

- **Presentation:** This mode is suitable for showing in front of public in connection to the PC.
- **Bright:** Maximum brightness from PC input.
- **Movie:** This mode is suitable for watching video.
- **sRGB:** Standardized accurate color.
- **Blackboard:** This mode should be selected to achieve optimum color settings when projecting onto a blackboard (green).
- **DICOM SIM.:** This mode can project a monochrome medical image such as an X ray radiography, MRI, etc.
- **User:** Memorize user's settings.
- **3D:** To experience the 3D effect, you need to have 3D glasses, make sure your PC/portable device has a 120 Hz signal output quad buffered graphics card and have a 3D Player installed.

Brightness

Adjust the brightness of the image.

- Press the ◀ to darken image.
- Press the ▶ to lighten the image.

Contrast

The contrast controls the degree of difference between the lightest and darkest parts of the picture.

- Press the ◀ to decrease the contrast.
- Press the ▶ to increase the contrast.

Sharpness

Adjust the sharpness of the image.

- Press the ◀ to decrease the sharpness.
- Press the ▶ to increase the sharpness.

USING THE PROJECTOR

Color

Adjust a video image from black and white to fully saturated color.

- Press the ◀ to decrease the amount of saturation in the image.
- Press the ▶ to increase the amount of saturation in the image.

Tint

Adjust the color balance of red and green.

- Press the ◀ to increase the amount of green in the image.
- Press the ▶ to increase the amount of red in the image.

Reset

Choose “Yes” to return the factory default settings for “IMAGE”.

Image Advanced menu

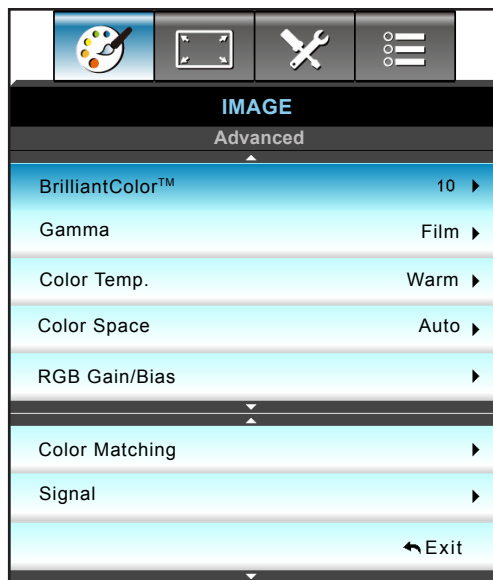

BrilliantColor™

This adjustable item utilizes a new color-processing algorithm and enhancements to enable higher brightness while providing true, more vibrant colors in picture.

- Press the ◀ to stronger enhance the image.
- Press the ▶ to less enhance the image.

Gamma

This allows you to set up gamma curve type. After the initial setup and fine tuning is completed, utilize the Gamma Adjustment steps to optimize your image output.

- Film: for home theater.
- Graphics: for PC / Photo source.
- 1.8 / 2.0 / 2.2 / 2.6: for specific PC / Photo source.
- Blackboard: This mode should be selected to achieve optimum color settings when projecting onto a blackboard (green).
- DICOM: This mode can project a monochrome medical image such as an X ray radiography, MRI, etc.
- Press the ◀ or ▶ to select the mode.

USING THE PROJECTOR

Color Temp.

Press the ◀ or ▶ to select a color temperature from Warm, Standard, Cool and Cold.

Color Space

Press the ◀ or ▶ to select an appropriate color matrix type from the following:

- Non-HDMI Input: Auto, RGB or YUV
- HDMI Input: Auto, RGB(0-255), RGB(16-235), or YUV.

RGB Gain/Bias

This settings allows to configure the brightness (gain) and contrast (bias) of an image.

- Press the ◀ to decrease a chosen color gain and bias.
- Press the ▶ to increase a chosen color gain and bias.



Color Matching

Press the ▶ into the next menu and then use ▲ or ▼ or ◀ or ▶ to select the item.



- Red/Green/Blue/Cyan/Magenta/Yellow: Use ◀ or ▶ to select Hue, Saturation and Gain Colors.

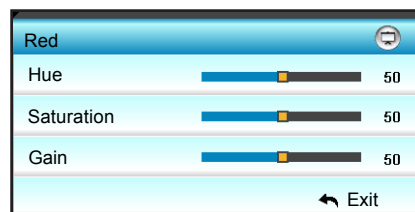

- White: Use ◀ or ▶ to select Red, Green and Blue Colors.

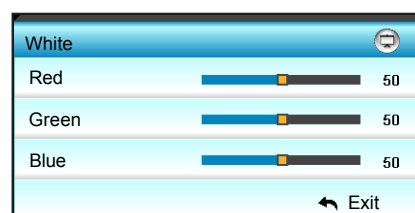

- Reset: Choose “\$ Reset” to return the factory default settings for color adjustments.

USING THE PROJECTOR

Exit

Choose "Exit" to exit the menu.

Image advanced signal (RGB) menu

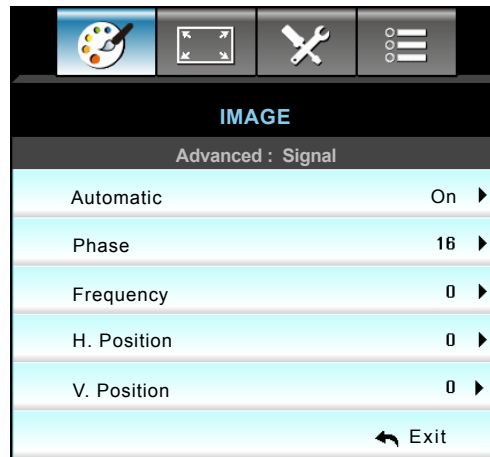

Note:

- "Signal" is only supported in Analog VGA (RGB) signal.
- If "Signal" is automatic, the phase, frequency items are grayed out. If "Signal" is not automatic, the phase, frequency items will appear for the user to manually tune and are saved in the settings after that for the next time projector is turned off and on again.

Automatic

Automatically selects the signal. If you use this function, the Phase, frequency items are grayed out, and if Signal is not automatic, the phase, frequency items will appear for user to manually tune and saved in settings after that for next time projector turns off and on again.

Phase

Synchronize the signal timing of the display with the graphic card. If the image appears to be unstable or flickers, use this function to correct it.

Frequency

Change the display data frequency to match the frequency of your computer's graphic card. Use this function only if the image appears to flicker vertically.

H. Position

- Press the ◀ to move the image left.
- Press the ▶ to move the image right.

V. Position

- Press the ◀ to move the image down.
- Press the ▶ to move the image up.

Exit

Choose "Exit" to exit the menu.

USING THE PROJECTOR

Image advanced signal (video) menu

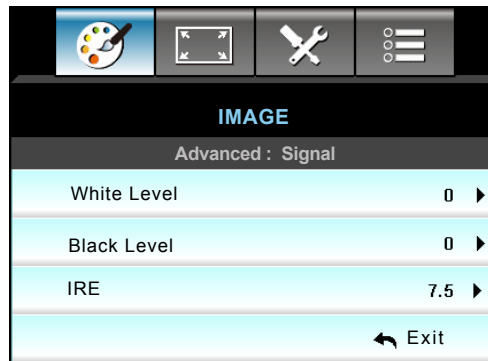

White Level

Allow user adjust White Level when inputting Video signals.

Black Level

Allow user adjust Black Level when inputting Video signals.

IRE

Allow user adjust IRE value when inputting Video signals.

Note: IRE is only available with NTSC video format.

- Press the ◀ to decrease the amount of color in the image.
- Press the ▶ to increase the amount of color in the image.

Display menu

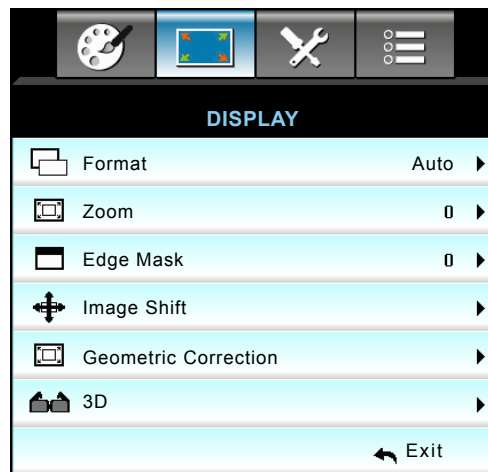

Format

Press the ◀ or ▶ to choose your desired aspect ratio between the following options:

- XGA: 4:3, 16:9, Native, Auto
- 1080p: 4:3, 16:9, LBX, Native, Auto
- WXGA: 4:3, 16:9 or 16:10, LBX, Native, Auto
- WUXGA: 4:3, 16:9 or 16:10, LBX, Native, Auto

USING THE PROJECTOR

About the formats:

- 4:3: This format is for 4:3 input sources.
- 16:9: This format is for 16:9 input sources, like HDTV and DVD enhanced for Wide screen TV.
- 16:10: This format is for 16:10 input sources, like widescreen laptops.
- LBX: This format is for non-16x9, letterbox source and for users who use external 16x9 lens to display 2.35:1 aspect ratio using full resolution.
- Native: This format displays the original image without any scaling.
- AUTO: Automatically selects the appropriate display format.

Note: Detailed informations about LBX mode:

- *Some Letter-Box Format DVDs are not enhanced for 16x9 TVs. In this situation, the image will not look right when displayed in 16:9 mode. In this situation, please try to using the 4:3 mode to view the DVD. If the content is not 4:3, there will be black bars around the image in 16:9 display. For this type of content, you can use LBX mode to fill the image on the 16:9 display.*
- *If you use an external anamorphic lens, this LBX mode also allows you to watch a 2.35:1 content (include Anamorphic DVD and HDTV film source) that support anamorphic wide is enhanced for 16x9 Display in a wide 2.35:1 image. In this case, there are no black bars. Lamp power and vertical resolution are fully utilized.*

WUXGA scaling table (screen type 16x10):

- Support Screen type 16:10 (1920 x 1200), 16:9 (1920 x 1080).
- When screen type is 16:9 there is no 16 x 10 format in this condition.
- When screen type is 16:10 there is no 16 x 9 format in this condition.
- If user change to auto, will auto change the display mode at same time.

16 : 10 screen	480i/p	576i/p	1080i/p	720p	PC
4x3	Scale to 1600x1200.				
16x9	Scale to 1920x1080.				
16x10	Scale to 1920x1200.				
LBX	Scale to 1920x1440, then get the central 1920x1200 image to display.				
Native mode	1:1 mapping centered. No scaling will be made; the resolution of the projection depends on the input source.				
Auto	If this format is selected, the screen type will automatically become 16:10 (1920x1200). -If source is 4:3, the screen type will be automatically resized to 1600x1200. -If source is 16:9, the screen type will be automatically resized to 1920x1080. -If source is 16:10, the screen type will be automatically resized to 1920x1200.				

USING THE PROJECTOR

WUXGA auto mapping rule (screen type 16x10):

Auto	Input resolution		Auto/Scale	
	H-resolution	V-resolution	1920	1200
4:3	640	480	1600	1200
	800	600	1600	1200
	1024	768	1600	1200
	1280	1024	1600	1200
	1400	1050	1600	1200
	1600	1200	1600	1200
Wide Laptop	1280	720	1920	1080
	1280	768	1920	1152
	1280	800	1920	1200
SDTV	720	576	1350	1080
	720	480	1620	1080
HDTV	1280	720	1920	1080
	1920	1080	1920	1080

WUXGA scaling table (screen type 16x9):

16 : 9 screen	480i/p	576i/p	1080i/p	720p	PC
4x3	Scale to 1440x1080.				
16x9	Scale to 1920x1080.				
LBX	Scale to 1920x1440, then get the central 1920x1080 image to display.				
Native mode	1:1 mapping centered. No scaling will be made; the resolution of the projection depends on the input source.				
Auto	If this format is selected, the screen type will automatically become 16:9 (1920x1080). -If source is 4:3, the screen type will be automatically resized to 1440x1080. -If source is 16:9, the screen type will be automatically resized to 1920x1080. -If source is 16:10, the screen type will be automatically resized to 1920x1200 and cut 1920x1080 area to display.				

USING THE PROJECTOR

WUXGA auto mapping rule (screen type 16x9):

Auto	Input resolution		Auto/Scale	
	H-resolution	V-resolution	1920	1080
4:3	640	480	1440	1080
	800	600	1440	1080
	1024	768	1440	1080
	1280	1024	1440	1080
	1400	1050	1440	1080
	1600	1200	1440	1080
Wide Laptop	1280	720	1920	1080
	1280	768	1800	1080
	1280	800	1728	1080
SDTV	720	576	1350	1080
	720	480	1620	1080
HDTV	1280	720	1920	1080
	1920	1080	1920	1080

WXGA scaling table (screen type 16x10):

- Support Screen type 16:9 (1280 x 720), 16:10 (1280 x 800).
- When screen type is 16:9 there is no 16 x 10 format in this condition.
- When screen type is 16:10 there is no 16 x 9 format in this condition.
- If user change to auto, will auto change the display mode at same time.

16 : 10 screen	480i/p	576i/p	1080i/p	720p	PC
4x3	Scale to 1066x800.				
16x10	Scale to 1280x800.				
LBX	Scale to 1280x960, then get the central 1280x800 image to display.				
Native mode	1:1 mapping centered		1:1 mapping display 1280 x 800	1280x720 Centered	1:1 mapping centered
Auto	Input source will be fit into 1280x800 display area and be kept its original aspect ratio. -If source is 4:3, auto resize to 1066 x 800. -If source is 16:9 auto resize to 1280 x 720. -If source is 15:9 auto resize to 1280 x 768. -If source is 16:10 auto resize to 1280 x 800.				

USING THE PROJECTOR

WXGA auto mapping rule (screen type 16x10):

Auto	Input resolution		Auto/Scale	
	H-resolution	V-resolution	1280	800
4:3	640	480	1066	800
	800	600	1066	800
	1024	768	1066	800
	1280	1024	1066	800
	1400	1050	1066	800
	1600	1200	1066	800
Wide Laptop	1280	720	1280	720
	1280	768	1280	768
	1280	800	1280	800
SDTV	720	576	1280	720
	720	480	1280	720
HDTV	1280	720	1280	720
	1920	1080	1280	720

WXGA scaling table (screen type 16x9):

16 : 9 screen	480i/p	576i/p	1080i/p	720p	PC
4x3	Scale to 960x720.				
16x9	Scale to 1280x720.				
LBX	Scale to 1280x960, then get the central 1280x720 image to display				
Native mode	1:1 mapping centered		1:1 mapping display 1280 x 720	1280x720 Centered	1:1 mapping centered
Auto	<p>If this format is select, Screen type will auto become 16:9 (1280x720).</p> <ul style="list-style-type: none"> -If source is 4:3, auto resize to 960x720. -If source is 16:9 auto resize to 1280x720. -If source is 15:9 auto resize to 1200x720. -If source is 16:10 auto resize to 1152x720. 				

USING THE PROJECTOR

WUXGA auto mapping rule (screen type 16x9):

Auto	Input resolution		Auto/Scale	
	H-resolution	V-resolution	1280	720
4:3	640	480	960	720
	800	600	960	720
	1024	768	960	720
	1280	1024	960	720
	1400	1050	960	720
	1600	1200	960	720
Wide Laptop	1280	720	1280	720
	1280	768	1200	720
	1280	800	1152	720
SDTV	720	576	1280	720
	720	480	1280	720
HDTV	1280	720	1280	720
	1920	1080	1280	720

1080P scaling table (screen type 16:9)

16 : 9 screen	480i/p	576i/p	1080i/p	720p	PC
4x3	Scale to 1440x1080.				
16x9	Scale to 1920x1080.				
LBX	Scale to 1920x1440, then get the central 1920x1080 image to display.				
Native mode	1:1 mapping centered. No scaling will be made; the resolution of the projection depends on the input source.				
Auto	If this format is selected, the screen type will automatically become 16:9 (1920x1080). -If source is 4:3, the screen type will be automatically resized to 1440x1080. -If source is 16:9, the screen type will be automatically resized to 1920x1080. -If source is 16:10, the screen type will be automatically resized to 1920x1200 and cut 1920x1080 area to display.				

USING THE PROJECTOR

1080P auto mapping rule (screen type 16x9):

Auto	Input resolution		Auto/Scale	
	H-resolution	V-resolution	1920	1080
4:3	640	480	1440	1080
	800	600	1440	1080
	1024	768	1440	1080
	1280	1024	1440	1080
	1400	1050	1440	1080
	1600	1200	1440	1080
Wide Laptop	1280	720	1920	1080
	1280	768	1800	1080
	1280	800	1728	1080
SDTV	720	576	1350	1080
	720	480	1620	1080
HDTV	1280	720	1920	1080
	1920	1080	1920	1080

XGA scaling table (screen type 16x9)

16 : 9 screen	480i/p	576i/p	1080i/p	720p
4x3	Scale to 1024x768.			
16x9	Scale to 1024x576.			
Native mode	No scaling will be made; the resolution of the projection depends on the input source.			
Auto	-If source is 4:3, the screen type will be automatically resized to 1024x768. -If source is 16:9, the screen type will be automatically resized to 1024x576. -If source is 15:9, the screen type will be automatically resized to 1024x614. -If source is 16:10, the screen type will be automatically resized to 1024x640.			

XGA auto mapping rule (screen type 16x9):

Auto	Input resolution		Auto/Scale	
	H-resolution	V-resolution	1280	768
4:3	640	480	1024	768
	800	600	1024	768
	1024	768	1024	768
	1600	1200	1024	768
Wide Laptop	1280	720	1024	576
	1280	768	1024	614
	1280	800	1024	640
SDTV	720	576	1024	576
	720	480	1024	576
HDTV	1280	720	1024	576
	1920	1080	1024	576

USING THE PROJECTOR

Zoom

- Press the ◀ to reduce the size of an image.
- Press the ▶ to magnify an image on the projection screen.

Edge Mask

Edge mask the image to remove video encoding noise on the edge of video source.

Note:

- Each I/O has different setting of "Edge Mask".
- "Edge Mask" and "Zoom" cannot work at the same time.

Image Shift

Press ▶ into the next menu as below and then use ▲ or ▼ or ◀ or ▶ to select item.

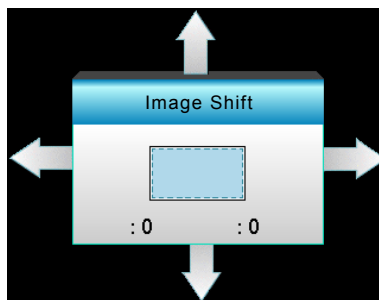

- H: Press the ◀▶ to shift the projected image position horizontally.
- V: Press the ▲▼ to shift the projected image position vertically.

Geometric Correction

- H. Keystone (Horizontal Keystone): Press the ◀▶ to correct horizontal keystone distortion.
- V. Keystone (Vertical Keystone): Press the ▲▼ to correct vertical keystone distortion.
- Auto V. Keystone: Automatically corrects vertical keystone error.
- Four corners: Compensate for image distortion by adjusting one corner at a time.

1. Use "Menu" to start.
2. Use "Four Corners" menu to choose one corner and press "Enter" to confirm.
3. Use ▲▼◀▶ to move the angle and press "Enter" to confirm.

Reset

Choose "Yes" to return the factory default settings for "IMAGE".

USING THE PROJECTOR

Display 3D menu



3D Mode

- DLP-Link: Select "DLP-Link" to use optimized settings for DLP Link 3D Glasses.
- VESA 3D: Select "VESA 3D" to use optimized setting for VESA 3D Glasses.
- Off: Select "Off" to turn off 3D mode.

3D -> 2D

- 3D: Display 3D signal.
- L (Left): Display the left frame of 3D content.
- R (Right): Display the right frame of 3D content.

3D Format

- Auto: When a 3D identification signal is detected, the 3D format is selected automatically.
- SBS: Display 3D signal in "Side-by-Side" format.
- Top and Bottom: Display 3D signal in "Top and Bottom" format.
- Frame Sequential: Display 3D signal in "Frame Sequential" format.

Note:

- "3D Format" is only supported on 3D Timing on page 69.
- "3D Format" is only supported on non-HDMI 1.4a 3D timing.

3D Sync. Invert

- Press the "On" to invert left and right frame contents.
- Press the "Off" for default frame contents.

Exit

Choose "Exit" to exit the menu.

USING THE PROJECTOR

Setup menu







Language

Choose the multilingual OSD menu. Press ► into the sub menu and then use the ▲ or ▼ or ◀ or ▶ key to select your preferred language. Press “Enter” to finalize the selection.

Language			
English	Nederlands	Čeština	Türkçe
Deutsch	Norsk/Dansk	عربي	فارسی
Français	Polski	繁體中文	Vietnamese
Italiano	Русский	简体中文	Romanian
Español	Suomi	日本語	Indonesian
Português	ελληνικά	한국어	Slovakian
Svenska	Magyar	ไทย	◀ Exit

Projection

-  Front
This is the default selection. The image is projected straight on the screen.
-  Rear
When selected, the image will appear reversed.
-  Front-Ceiling
When selected, the image will turn upside down.
-  Rear-Ceiling
When selected, the image will appear reversed in upside down position.

USING THE PROJECTOR

Note: Rear-Desktop and Rear-Ceiling are to be used with a translucent screen.

Screen Type

Choose the screen type from 16:10 or 16:9 (WXGA/WUXGA).

Note: “Screen Type” is for WXGA/WUXGA only.

Menu Location

Choose the menu location on the display screen.

Projector ID

ID definition can be set up by menu (range 0-99), and allow user control an individual projector by RS232.

HDBaseT Control

The projector can automatically detect the Ethernet or RS232 signal from the HDBaseT transmitter supplied. For an automatic detection, make sure the respective signal is enabled.

Exit

Choose “Exit” to exit the menu.

Setup Security menu



Security

- On: Choose “On” to use security verification when the turning on the projector.
- Off: Choose “Off” to be able to switch on the projector without password verification.

Security Timer

Can be select the time (Month/Day/Hour) function to set the number of hours the projector can be used. Once this time has elapsed you will be requested to enter your password again.

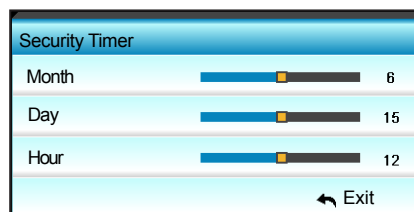

Change Password

- **First time:**
 1. Press “Enter” key to set the password.
 2. The password has to be 4 digits.
 3. Use number button on the remote or on-screen numeric keypad to enter your new password and then press “Enter” key to confirm your password.

USING THE PROJECTOR

- **Change Password:**
(If your remote does not have a number keypad, please use the up/down arrows to change each digit of the password, then press enter to confirm)
 1. Press “Enter” to input old password.
 2. Use number button or on-screen numeric keypad to enter current password and then press “Enter” to confirm.
 3. Enter new password (4 digits in length) using the number buttons on the remote, then press “Enter” to confirm.
 4. Enter new password again and press “Enter” to confirm.If the incorrect password is entered 3 times, the projector will automatically shut down.
If you have forgotten your password, please contact your local office for support.

Note: The password default value is “1234” (first time).

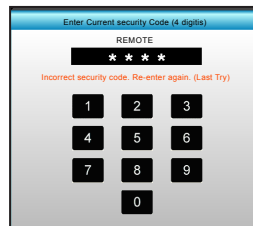

Exit

Choose “Exit” to exit the menu.

Setup Audio Settings menu

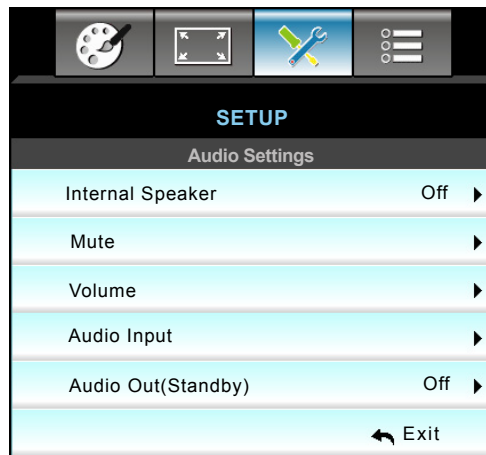

Internal Speaker

Choose the “On” or “Off” to turn on or off the internal speaker.

Mute

- Choose the “On” to turn mute on.
- Choose the “Off” to turn mute off.

Note: “Mute” function affects both internal and external speaker volume.

Volume

- Press the ◀ to decrease the audio or microphone volume.
- Press the ▶ to increase the audio or microphone volume.

USING THE PROJECTOR

Audio Input

The default audio settings are on the back panel of the projector. Use this option to reassign any of the Audio Inputs (1, 2, or 3) to the current image source. Each Audio input can be assigned to more than one video source.

- Default: VGA 1 -> Audio 1; VGA 2 -> Audio 2
- Audio 1 / 2: Mini jack connection.
- Audio 3: L/R.

Audio Out (Standby)

Choose the “On” or “Off” to turn on or off the audio out.

Exit

Choose “Exit” to exit the menu.

Setup advanced menu

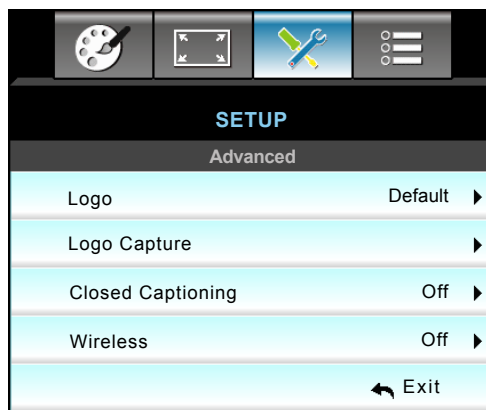

Logo

Use this function to set the desired startup screen. If changes are made they will take effect the next time the projector is powered on.

- Default: The default startup screen.
- Neutral: Logo is not displayed on startup screen.
- User: Use stored picture from “Logo Capture” function

Logo Capture

Use to capture an image of the picture currently displayed on the screen.

Note:

- *For a successful logo capture, ensure that the on-screen image does not exceed the projector native resolution.
If logo capture is still unsuccessful please try using a less detailed image.*
- *This feature is exclusively for capturing logos and not for capturing large-scale images.*

Closed Captioning

Closed Captioning is a text version of the program sound or other information displayed on the screen. If the input signal contains closed captions, you can turn on the feature and watch the channels. Press ◀ or ▶ to select Off, CCI, or CC2.

USING THE PROJECTOR

Wireless

Choose the “On” or “Off” to turn on or off the wireless function.

Exit

Choose “Exit” to exit the menu.

Setup network LAN settings menu

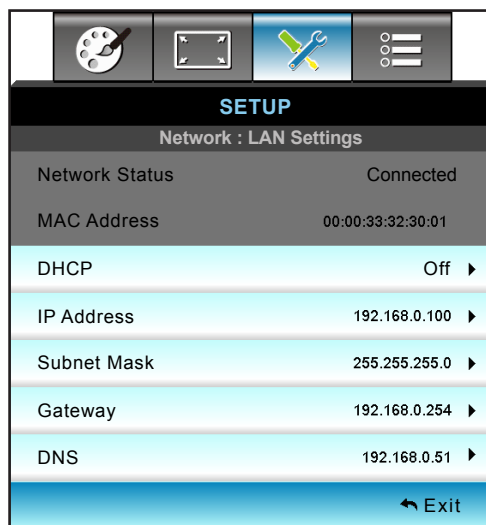

Network Status

Display the network connection status (read-only).

MAC Address

Display the MAC address (read-only).

DHCP

- On: Projector will obtain an IP address automatically from your network.
- Off: To assign IP, Subnet Mask, Gateway and DNS configuration manually.

Note: Exiting OSD will automatically apply the entered values.

IP Address

Display the IP address.

Subnet Mask

Display subnet mask number.

Gateway

Display the default gateway of the network connected to the projector.

DNS

Display DNS number.

Exit

Choose “Exit” to exit the menu.

Reset

Choose “Yes” to return the factory default settings for “Network”.

USING THE PROJECTOR

How to use web browser to control your projector

1. Turn “On” the DHCP option on projector to allow a DHCP server to automatically assign an IP address.
2. Open the web browser in your PC and type in the projector’s IP address (“Network: LAN Settings > IP Address”).
3. Enter the user name and password, and click “Login”.
The projector’s configuration web interface opens.

Note:

- The default user name and password is “admin”.
- The steps in this section base on Windows 7 operating system.

Making a direct connection from your computer to the projector*

1. Turn “Off” the DHCP option on project.
2. Configure the IP address, Subnet Mask, Gateway, and DNS on projector (“Network: LAN Settings”).

IP Address	192.168.0.100 ▶
Subnet Mask	255.255.255.0 ▶
Gateway	192.168.0.254 ▶
DNS	192.168.0.51 ▶

3. Open Network and Sharing Center page on your PC, and assign the identical network parameters to your PC as set on projector. Click “OK” to save the parameters.

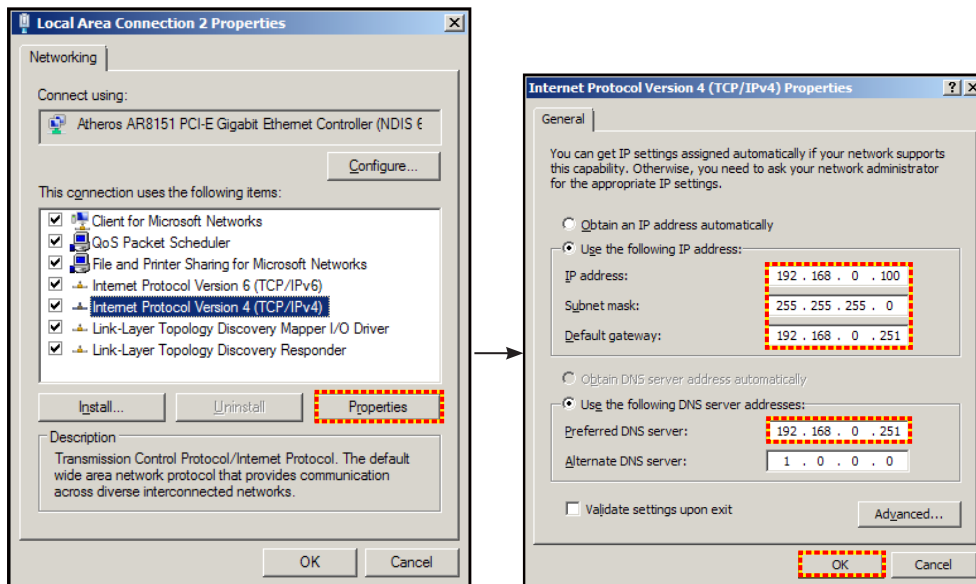

4. Open the web browser on your PC and type in to the URL field the IP address, assigned in step 3. Then press “Enter” key.

USING THE PROJECTOR

Setup network control settings menu

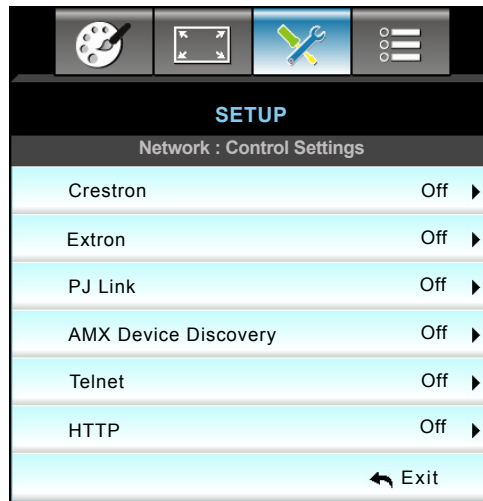

Crestron

Use this function to select the network function (port: 41794).

For more information, please visit <http://www.crestron.com> and www.crestron.com/getroomview.

Extron

Use this function to select the network function (port: 2023).

PJ Link

Use this function to select the network function (port: 4352).

AMX Device Discovery

Use this function to select the network function (port: 9131).

Telnet

Use this function to select the network function (port: 23).

HTTP

Use this function to select the network function (port: 80).

Exit

Choose "Exit" to exit the menu.

USING THE PROJECTOR

Setup network control settings menu

LAN_RJ45 function

For simplicity and ease of operation, the W320UST projector provides diverse networking and remote management features. The LAN/RJ45 function of the projector through a network, such as remotely manage: Power On/Off, Brightness and Contrast settings. Also, projector status information, such as: Video- Source, Sound-Mute, etc.

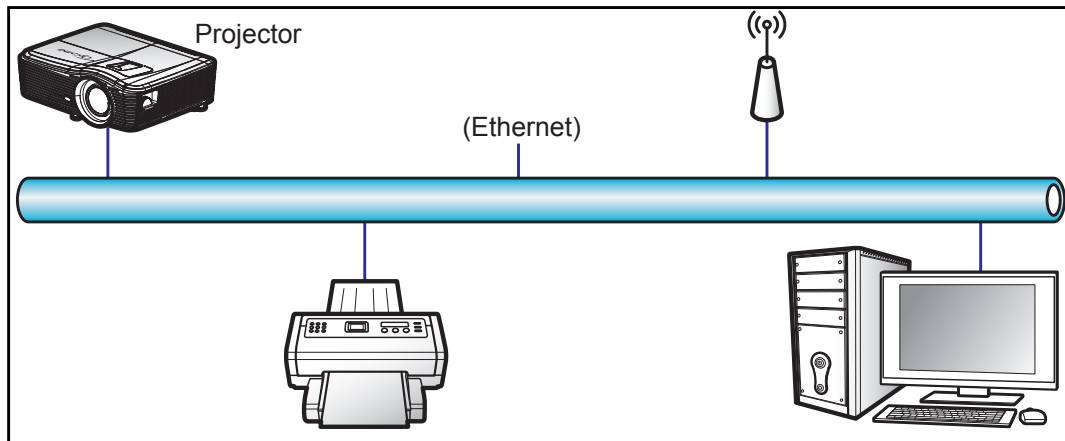

Wired LAN terminal functionalities

This projector can be controlled by using a PC (laptop) or other external device via LAN/RJ45 port and compatible with Crestron / Extron / AMX (Device Discovery) / PJLink.

- Crestron is a registered trademark of Crestron Electronics, Inc. of the United States.
- Extron is a registered trademark of Extron Electronics, Inc. of the United States.
- AMX is a registered trademark of AMX LLC of the United States.
- PJLink applied for trademark and logo registration in Japan, the United States of America, and other countries by JBMIA.

The projector is supported by the specified commands of the Crestron Electronics controller and related software, for example RoomView®.

<http://www.crestron.com/>

This projector is compliant to support Extron device(s) for reference.

<http://www.extron.com/>

This projector is supported by AMX (Device Discovery).

<http://www.amx.com/>

This projector supports all commands of PJLink Class1 (Version 1.00).

<http://pjlink.jbmia.or.jp/english/>

For more detailed information about the various types of external devices which can be connected to the LAN/RJ45 port and remote/control the project, as well as the supported commands for these external devices, please contact the Support-Service directly.

USING THE PROJECTOR

LAN RJ45

1. Connect an RJ45 cable to RJ45 ports on the projector and the PC (laptop).

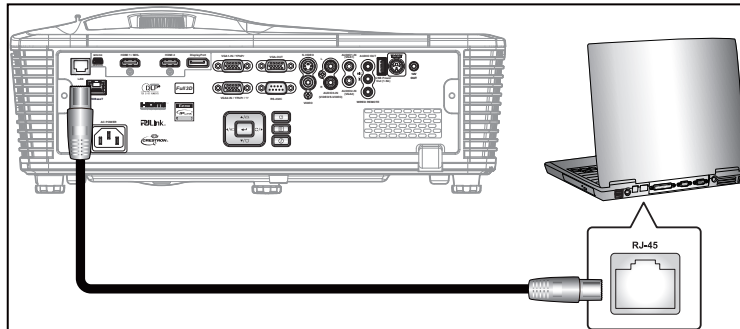

2. On the PC (Laptop), select Start > Control Panel > Network Connections.

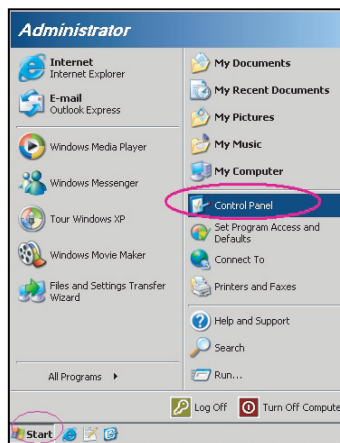

3. Right-click on the Local Area Connection, and select Property.

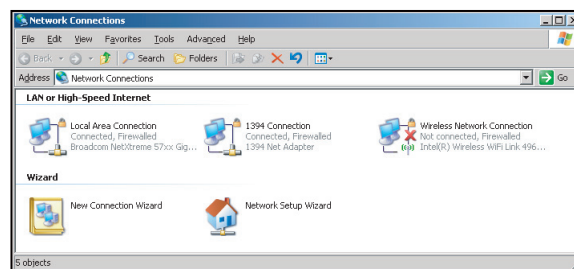

4. In the Properties window, select the General tab, and select Internet Protocol (TCP/IP).

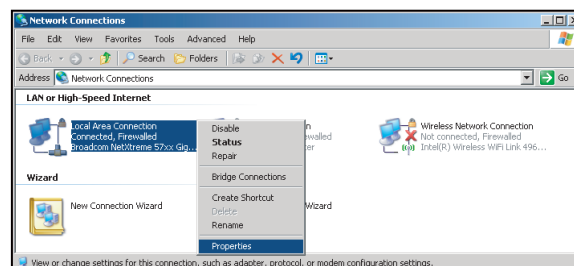

USING THE PROJECTOR

5. Click "Properties".

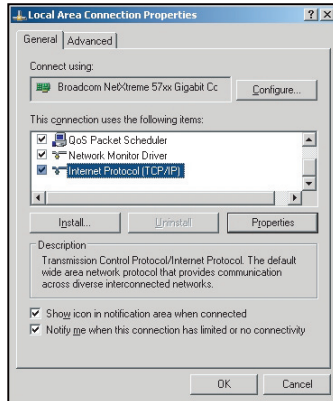

6. Type in the IP address and Subnet mask, then press "OK".

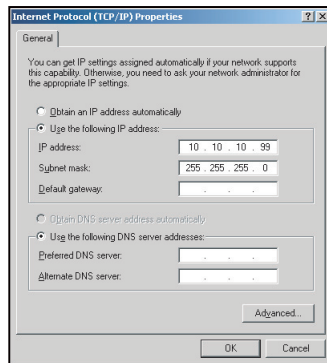

7. Press the "Menu" button on the projector.
8. Use ◀▶ keys to select SETUP > Network > LAN Settings.
9. After getting into LAN Settings, input the following connection parameters:
 - DHCP: Off
 - IP Address: 10.10.10.10
 - Subnet Mask: 255.255.255.255
 - Gateway: 0.0.0.0
 - DNS: 0.0.0.0
10. Press "Enter" to confirm settings.
11. Open a web browser, for example Microsoft Internet Explorer, with Adobe Flash Player 9.0 or higher installed.
12. In the Address bar, input the projector's IP address: 10.10.10.10.

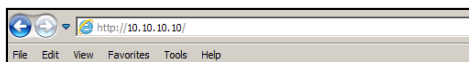

13. Press "Enter".
The projector is setup for remote management. The LAN/RJ45 function displays as follows:

USING THE PROJECTOR

Information page

Model: Optoma Logout Tools Info Help

Optoma

Projector Information		Projector Status	
Projector Name	EX10ST1	Power Status	On
Location	Room	Source	HDMI
Firmware	B02.2011-09-21	Preset Mode	Presentation
Mac Address	00:50:41:77:31:24	Projector Position	Front Table
Resolution	0 x 0 0Hz	Lamp Mode	STD
Lamp Hours	10	Error Status	
Assigned To	Sir		

exit

Main page

Model: Optoma Tools Info Help

Optoma

Power Vol - Mute Vol +

SourceList

VGA1
VGA2
Video
HDMI
Flash Drive

Menu ▲ Auto

◀ OK ▶

AV Mute ▼ Source

Freeze Contrast Brightness Color

Tool page

Model: Optoma Logout Tools Info Help

Optoma

Creston Control	Projector	User Password
IP Address: 192.168.0.2	Projector Name: EX10ST1	<input type="checkbox"/> Enabled
IP ID: 5	Location: Room	New Password: _____
Port: 41794	Name: Sir	Confirm: _____
<input type="button" value="Send"/>	<input type="button" value="Send"/>	<input type="button" value="Send"/>
Default Language: Automatic	DHCP: <input type="checkbox"/> DHCP Enabled	Admin Password: <input type="checkbox"/> Enabled
<input type="button" value="Send"/>	IP Address: 192.168.0.100	New Password: _____
	Subnet Mask: 255.255.255.0	Confirm: _____
	Default Gateway: 192.168.0.254	<input type="button" value="Send"/>
	DNS Server: 192.168.0.51	
	Host Name: _____	
	<input type="button" value="Send"/>	

exit

Contact IT helpdesk

HELP DESK

Send

USING THE PROJECTOR

RS232 by Telnet Function

There is alternative RS232 command control way, in projector so called “RS232 by TELNET” for LAN/RJ45 interface.

Quick Start-Guide for “RS232 by Telnet”

- Check and get the IP address on OSD of the projector.
- Make sure that the PC/laptop can access the web-page of the projector.
- Make sure that “Windows Firewall” setting is set disabled in case of “TELNET” function filtering out by PC/laptop.

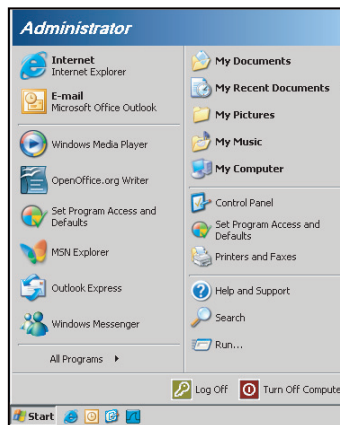

1. Start > All Programs > Accessories > Command Prompt.

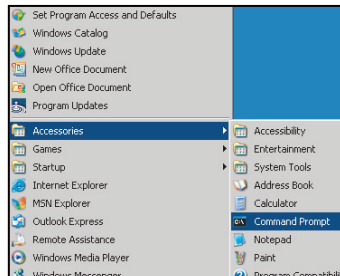

2. Input the command format as follows:
 - telnet ttt.xxx.yyy.zzz 23 (“Enter” key pressed)
 - (ttt.xxx.yyy.zzz: IP-Address of the projector)
3. If Telnet-Connection ready, and user can have RS232 command input, then “Enter” key pressed, the RS232 command will be workable.

Specification for “RS232 by TELNET”:

1. Telnet: TCP.
2. Telnet port: 23 (for more detail, kindly please get contact with the service agent or team).
3. Telnet utility: Windows “TELNET.exe” (console mode).
4. Disconnection for RS232-by-Telnet control normally: Close
5. Windows Telnet utility directly after TELNET connection ready.
 - Limitation 1 for Telnet-Control: there is less than 50 bytes for successive network payload for Telnet-Control application.
 - Limitation 2 for Telnet-Control: there is less than 26 bytes for one complete RS232 command for Telnet-Control.
 - Limitation 3 for Telnet-Control: Minimum delay for next RS232 command must be more than 200 (ms).

USING THE PROJECTOR

Options menu

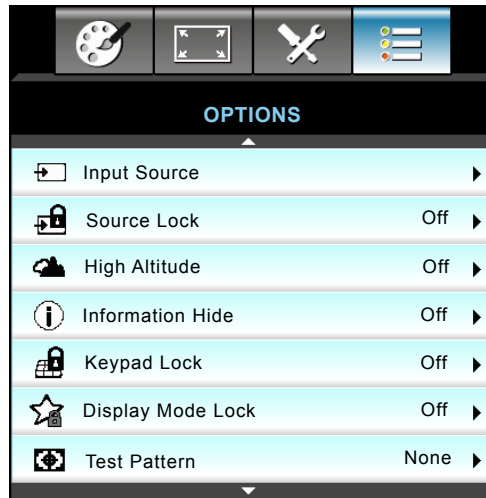

Input Source

Use this option to enable/disable input sources. Press ► to enter the sub menu and select which sources you require. Press “Enter” to finalize the selection. The projector will only search for inputs that are enabled.

Source Lock

- On: The projector will only search current input connection.
- Off: The projector will search for other signals if the current input signal is lost.

High Altitude

When “On” is selected, the fans will spin faster. This feature is useful in high altitude areas where the air is thin.

Information Hide

- On: Choose “On” to hide the info message.
- Off: Choose “Off” to show the “searching” message.

Keypad Lock

When the keypad lock function is "On", the Keypad will be locked however, the projector can be operated by the remote control. By selecting "Off", you will be able to reuse the Keypad.

Display Mode Lock

- On: Lock adjusting display mode settings.
- Off: Unlock adjusting display mode settings.

Test Pattern

Display a test pattern. There are Grid, White Pattern and None.

USING THE PROJECTOR

Options menu (continued)

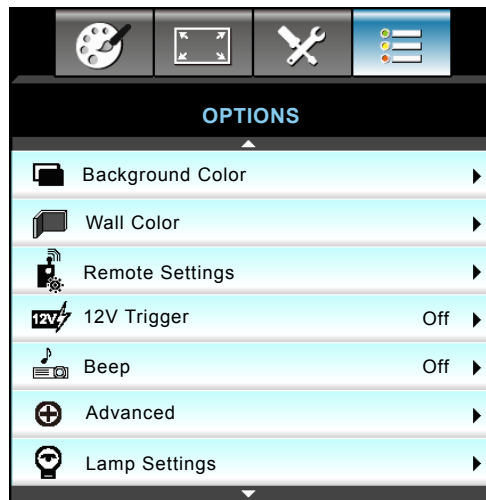

Background Color

Use this feature to display a “Black”, “Red”, “Blue”, “Green” or “White”, screen when no signal is available.

Wall Color

Use this function to obtain an optimized screen image according to the wall color. The available options: “Light Yellow”, “Light Green”, “Light Blue”, “Pink”, and “Gray”. Select “Off” to turn off this function.

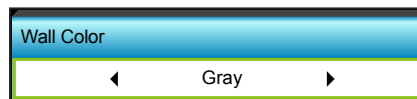

12V Trigger

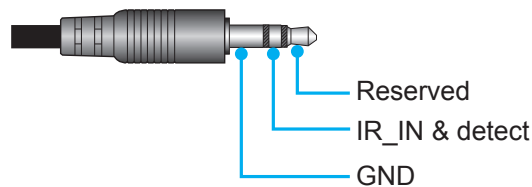

- Off: Choose “Off” to disable the trigger.
- On: Choose “On” to enable the trigger.

Beep

- Off: No beep sound is audible when a key is pressed or in an error event.
- On: Beep sound is audible when a key is pressed or in an error event.

USING THE PROJECTOR

Options remote settings menu

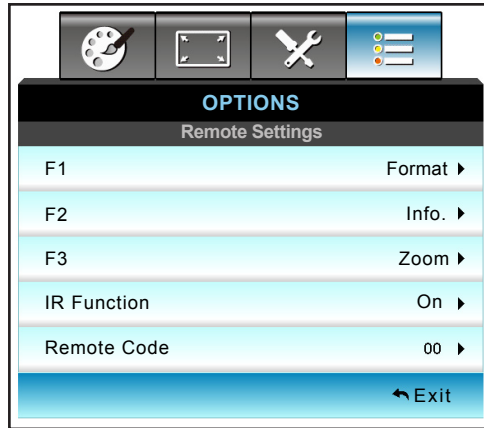

F1

The default value is "Test Pattern".

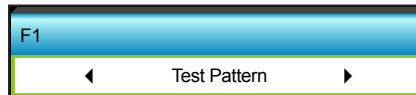

- Press ► into the next menu and then use ◀ or ▶ to select "HDMI2", "DP", "VGA2", "S-Video", "Test Pattern", "Zoom", "Info", or "Format" item.

Note: For models with HDBaseT, the default value of "F1" is "HDBaseT".

F2

The default value is "Zoom".

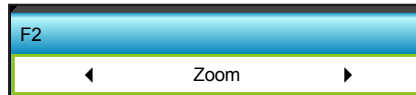

- Press ► into the next menu and then use ◀ or ▶ to select "HDMI2", "DP", "VGA2", "S-Video", "Test Pattern", "Zoom", "Info", or "Format" item.

Note: For models with HDBaseT, the default value of "F2" is "HDBaseT".

F3

The default value is "Info".

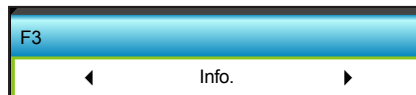

- Press ► into the next menu and then use ◀ or ▶ to select "HDMI2", "DP", "VGA2", "S-Video", "Test Pattern", "Zoom", "Info", or "Format" item.

Note: For models with HDBaseT, the default value of "F1" is "HDBaseT".

IR Function

- On: Choose "On", the projector can be operated by the remote control from front or top IR receiver.
- Front: Choose "Front", the projector can be operated by the remote control from front IR receiver.
- Top: Choose "Top", the projector can be operated by the remote control from top IR receiver.
- Off: Choose "Off", the projector can't be operated by the remote control from front or top IR receiver. By selecting "Off", you will be able to use the Keypad keys.

USING THE PROJECTOR

Note:

- “Front” and “Top” cannot be selected in standby mode.
- IR mode can be switched to “NVIDIA 3D Vision” once implemented and verified by NVIDIA.

Remote Code

- Press ► to set Remote custom code and press “Enter” to change to the setting.

Exit

Choose “Exit” to exit the menu.

Options advanced menu



Direct Power On

Choose “On” to activate Direct Power mode. The projector will automatically power on when AC power is supplied, without pressing the “⏻” key on the projector Control Panel or on the remote control.

Signal Power On

Choose “On” to activate Signal Power mode. The projector will automatically power on when a signal is detected, without pressing the “⏻” key on the projector Control Panel or on the remote control.

Auto Power Off (min)

Sets the countdown timer interval. The countdown timer will start, when there is no signal being sent to the projector. The projector will automatically power off when the countdown has finished (in minutes).

- Press the ◀ to decrease the timer interval.
- Press the ▶ to increase the timer interval.

Note:

- The value of sleep timer will be reset to zero after the projector is powered off.
- The projector will automatically power off when the countdown has finished.

Sleep Timer (min)

Sets the countdown timer interval. The countdown timer will start, with or without a signal being sent to the projector. The projector will automatically power off when the countdown has finished (in minutes).

- Press the ◀ to decrease the timer interval.
- Press the ▶ to increase the timer interval.

Note:

- Check “Always On” option to disable automatic power off.

USING THE PROJECTOR

Power Mode (Standby)

- Active: Choose “Active” to return to normal standby.
- Eco: Choose “Eco” to save power dissipation further < 0.5W.

Exit

Choose “Exit” to exit the menu.

Note: “Signal Power On” and “Power Mode (Standby)” options are optional features depending on model and region.

USING THE PROJECTOR

Options lamp settings menu

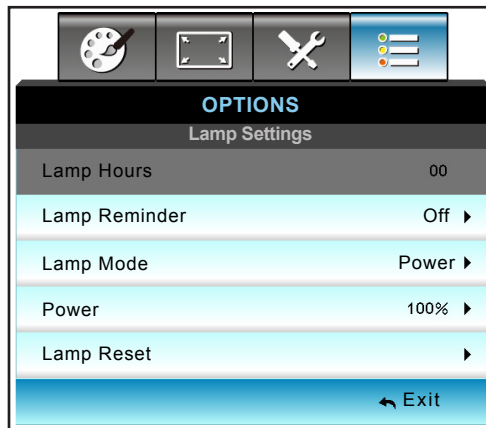

Lamp Hours

Display the projection time.

Lamp Reminder

Choose this function to show or to hide the warning message when the changing lamp message is displayed. The message will appear 30 hours before suggested replacement of lamp.

Lamp Mode

- Bright: Choose “Bright” to increase the brightness.
- Eco.: Choose “Eco” to dim the projector lamp which will lower power consumption and extend the lamp life.
- Power: Choose this option if you want to set the projector power setting manually.

Note:

- *When ambient temperature is over 40°C in operating, the projector will switch to Eco automatically.*
- *“Lamp Mode” can be independently set for 2D and 3D.*

Power

Set the projector power manually. The available options include 100%, 95%, 90%, 85%, and 80%.

Lamp Reset

Resets the lamp hour counter after replacing the lamp.

Exit

Choose “Exit” to exit the menu.

Options menu

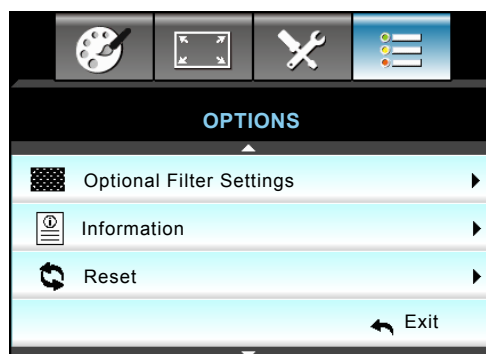

USING THE PROJECTOR

Information

Display the projector information.

Information	
S/N Number	xxxxxxxxxx
F/W Version	Main C01
	MCU C01
	LAN C01
Current Input Source	VGA 1
Resolution	1280x800
Refresh Rate	60.00 Hz
Lamp Hours	
	Bright 0 H
	Eco 0 H
	Power 0 H
Filter Hour	0 H
Projector ID	0
Remote Code	0
Remote Code (Active)	0
IP Address	192.168.1.1
Network Status	Connected

↩ Exit

Exit

Choose “Exit” to exit the menu.

Reset

Choose “Yes” to return the factory default settings for “OPTIONAL FILTER”.

Options optional filter settings menu

OPTIONS	
Optional Filter Settings	
Filter Usage Hours	500
Optional Filter Installed	Yes ▶
Filter Reminer	1000hr ▶
Filter Reset	▶

↩ Exit

Optional Filter Installed

- Yes: Display warning message after 500 hours of use.
- No: Turn off warning message.

Note: “Filter Usage Hours / Filter Reminder / Filter Reset” will only appear when “Optional Filter Installed” is “Yes”.

Filter Usage Hours

Display the filter time.

Filter Reminder

Choose this function to show or hide the warning message when the changing filter message is displayed. (Factory default setting: 500 hours).

Filter Reset

Reset the dust filter counter after replacing or cleaning the dust filer.

Exit

Choose “Exit” to exit the menu.

USING THE PROJECTOR

3D Setup

1. Turn on your projector.
2. Connect your 3D source. For example, 3D Blu ray, Games console, PC, Set top box, etc.
3. Ensure you have inserted 3D content or selected the 3D channel.
4. Turn on your 3D glasses. Please refer to the 3D glasses user manual on how to operate the 3D glasses.
5. Your projector will automatically display 3D from a 3D Blu-ray. For 3D via a set top box or PC you will be required to adjust the settings in the 3D menu.

For 3D via Blu ray

3D will automatically be displayed. Depending on the 3D glasses you have you will either need to select DLP Link or VESA in the menu. VESA glasses come with an emitter that must be connected to the 3D Sync port of the projector. Please refer to page 42.

- Menu > “Display” > “3D” > “3D Mode” > “DLP Link”
- Menu > “Display” > “3D” > “3D Mode” > “VESA 3D”

For 3D via a PC or Set top box

3D will not be displayed automatically. Depending on the 3D content the image will either be displayed side by side or top and bottom. Please refer to the following table.

SBS	SBS	Top and bottom
		Top and bottom

- For side by side images select “SBS” in the menu. Menu > “Display” > “3D” > “3D Format” > “SBS”.
 - For top and bottom images select “top and bottom” in the menu. Menu > “Display” > “3D” > “3D Format” > “Top and bottom”.
- If the 3D image does not look correct you may also be required to adjust the 3D sync invert. Turn this on if the image looks odd. Menu > “Display” > “3D” > “3D Sync Invert” > “On”.

Note: *If input video is normal 2D, please press “3D format” and switch to “Auto”. If “SBS” mode is active, 2D video content will not be displayed correctly. Please change back to “Auto” when 3D via a PC only works with certain resolutions. Please check the compatibility on page 69.*

MAINTENANCE

Replacing the lamp

The projector automatically detects the lamp life. When the lamp life is nearing the end of use, you will receive a warning message.

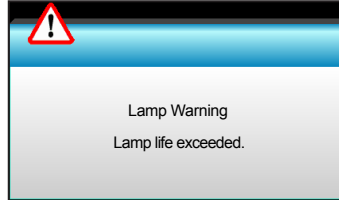

When you see this message, please contact your local reseller or service center to change the lamp as soon as possible. Make sure the projector has been cooled down for at least 30 minutes before changing the lamp.



Warning: If ceiling mounted, please use caution when opening the lamp access panel. It is recommended to wear safety glasses if changing the bulb when ceiling mounted. "Caution must be used to prevent any loose parts from falling out of projector."



Warning: Lamp compartment is hot! Allow it to cool down before changing lamp!



Warning: To reduce the risk of personal injury, do not drop the lamp module or touch the lamp bulb. The bulb may shatter and cause injury if it is dropped.

MAINTENANCE

Replacing the lamp (continued)

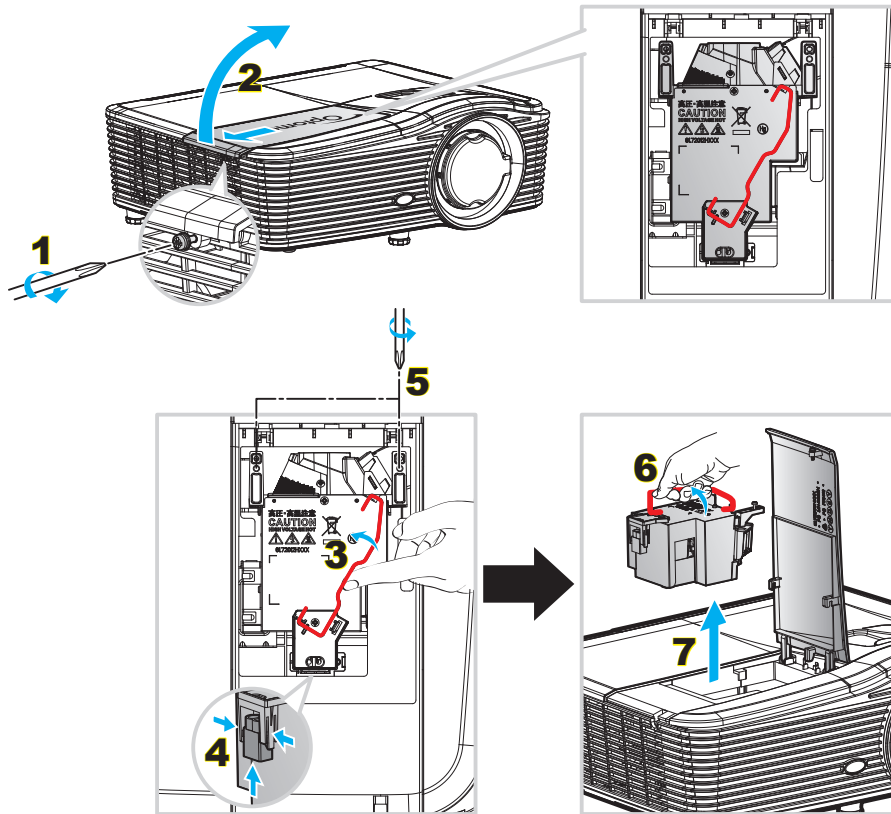

Procedure:

1. Switch off the power to the projector by pressing the "⏻" button on the remote control or on the Keypad of the projector.
2. Allow the projector to cool down for at least 30 minutes.
3. Disconnect the power cord.
4. Unscrew the one screw on the cover. **1**
5. Open the cover. **2**
6. Lift up the lamp handle. **3**
7. Press on the both sides then lift up and remove the lamp cord. **4**
8. Unscrew the one screw on the lamp module. **5**
9. Lift up the lamp handle **6** and remove the lamp module slowly and carefully. **7**
10. To replace the lamp module, reverse the previous steps.
11. Turn on the projector and reset the lamp timer.
12. Lamp Reset: (i) Press "Menu" → (ii) Select "OPTIONS" → (iii) Select "Lamp Settings" → (iv) Select "Lamp Reset" → (v) Select "Yes".

Note:

- *The screw on the lamp cover and the lamp cannot be removed.*
- *The projector cannot be turned on if the lamp cover has not been placed back on the projector.*
- *Do not touch the glass area of the lamp. Hand oil can cause the lamp shatter. Use a dry cloth to clean the lamp module if it was accidentally touched.*

MAINTENANCE

Cleaning the dust filter

Removing the dust filter cover

Procedure:

CAUTION: To avoid damage, you need to support the dust filter cover with your both hands when removing it.

1. Place the tips of your index fingers under the bottom edge of the dust filter cover.
2. Using the index finger and thumb of your both hands, hold the dust filter cover firmly.
3. Slightly move the dust filter cover to the left and to the right direction to release it from the latches on the case. And then remove.

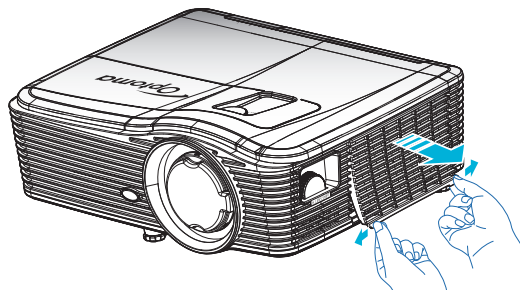

Installing the dust filter

Procedure:

1. Install the guide holes on the dust filter to the guide pins on the dust filter cover.
2. Install the dust filter cover assembly to the case.

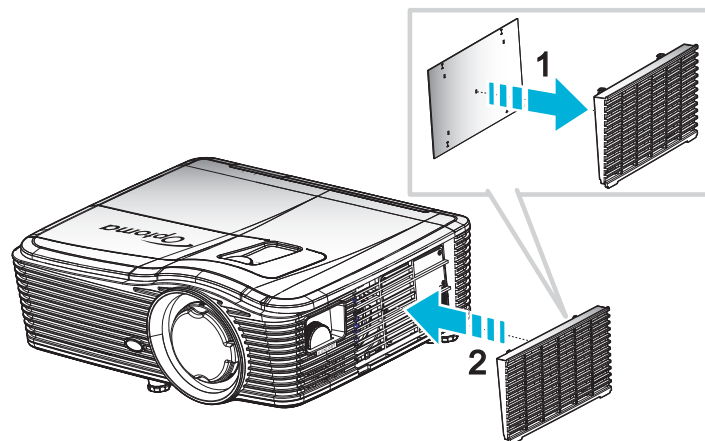

Note: Dust filters are only required/supplied in the selected regions with excessive dust.

MAINTENANCE

Cleaning the dust filter

We recommend cleaning the dust filter every three months; clean it more often if the projector is used in a dusty environment.

Procedure:

1. Switch off the power to the projector by pressing the “**⏻**” button on the remote control or on the Keypad of the projector.
2. Disconnect the power cord.
3. Remove the dust filter slowly and carefully.
4. Clean or replace the dust filter.
5. To install the dust filter, reverse the previous steps.

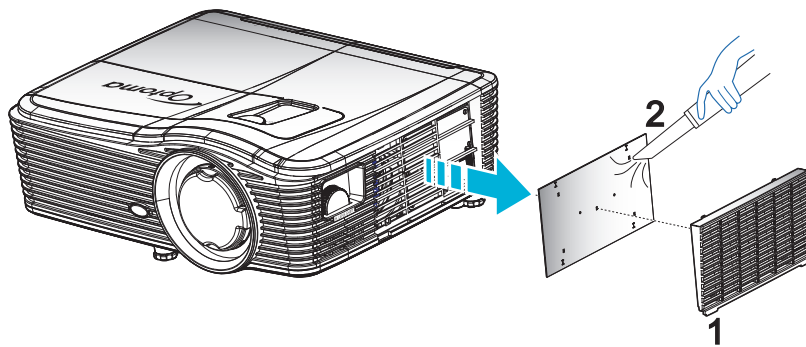

ADDITIONAL INFORMATION

Compatible resolutions

HDMI compatibility

B0/Established Timing	B0/Standard Timing	B0/Detail Timing	B1/Video Mode	B1/Detail Timing
720x400@70Hz	XGA/WXGA:	Native timing:	640x480p@60Hz	1366x768@60Hz
640x480@60Hz	1440x900@60Hz	XGA: 1024x768@60Hz	720x480p@60Hz	1920x1080@60Hz
640x480@67Hz	1024x768@120Hz	WXGA: 1280x800@60Hz	1280x720p@60Hz	1920x1200@60Hz(RB)
640x480@72Hz	1280x800@60Hz	1080P: 1920x1080@60Hz	1920x1080i@60Hz	
640x480@75Hz	1280x1024@60Hz	WUXGA: 1920x1200@60Hz(RB)	720(1440)x480i@60Hz	
800x600@56Hz	1680x1050@60Hz		1920x1080p@60Hz	
800x600@60Hz	1280x720@60Hz		720x576p@50Hz	
800x600@72Hz	1280x720@120Hz		1280x720p@50Hz	
800x600@75Hz	1600x1200@60Hz		1920x1080i@50Hz	
832x624@75Hz	1080P/WUXGA:		720(1440)x576i @50Hz	
1024x768@60Hz	1280x720@60Hz		1920x1080p@50Hz	
1024x768@70Hz	1280x800@60Hz		1920x1080p@24Hz	
1024x768@75Hz	1280 x1024@60Hz		1920x1080p@30Hz	
1280x1024@75Hz	1400x1050@60Hz			
1152x870@75Hz	1600x1200@60Hz			
	1440x900@60Hz			
	1280x720@120Hz			
	1024x768@120Hz			

ADDITIONAL INFORMATION

VGA analog compatibility

B0/Established Timing	B0/Standard Timing	B0/Detail Timing	B1/Video Mode	B1/Detail Timing
720x400@70Hz	XGA/WXGA:	Native timing:		1366x768@60Hz
640x480@60Hz	1440x900@60Hz	XGA: 1024x768@60Hz		1920x1080@60Hz
640x480@67Hz	1024x768@120Hz	WXGA: 1280x800@60Hz		1920x1200@60Hz (RB)
640x480@72Hz	1280x800@60Hz	1080P: 1920x1080@60Hz		
640x480@75Hz	1280x1024@60Hz	WUXGA: 1920x1200 @60Hz(RB)		
800x600@56Hz	1680x1050@60Hz			
800x600@60Hz	1280x720@60Hz			
800x600@72Hz	1280x720@120Hz			
800x600@75Hz	1600x1200@60Hz			
832x624@75Hz	1080P/WUXGA:			
1024x768@60Hz	1280x720@60Hz			
1024x768@70Hz	1280x800@60Hz			
1024x768@75Hz	1280x1024@60Hz			
1280x1024@75Hz	1400x1050@60Hz			
1152x870@75Hz	1600x1200@60Hz			
	1440x900@60Hz			
	1280x720@120Hz			
	1024x768@120Hz			

Display port digital compatibility

B0/Established Timing	B0/Standard Timing	B0/Detail Timing	B1/Video Mode	B1/Detail Timing
720x400@70Hz	XGA/WXGA:	Native timing:	640x480p@60Hz	1366x768@60Hz
640x480@60Hz	1440x900@60Hz	XGA: 1024x768@60Hz	720x480p@60Hz	1920x1080@60Hz
640x480@67Hz	1024x768@120Hz	WXGA: 1280x800@60Hz	1280x720p@60Hz	1920x1200@60Hz
640x480@72Hz	1280x800@60Hz	1080P: 1920x1080@60Hz	1920x1080i@60Hz	
640x480@75Hz	1280x1024@60Hz	WUXGA: 1920x1200 @60Hz(RB)	720(1440)x480i@60Hz	
800x600@56Hz	1680x1050@60Hz		1920x1080p@60Hz	
800x600@60Hz	1280x720@60Hz		720x576p@50Hz	
800x600@72Hz	1280x720@120Hz		1280x720p@50Hz	
800x600@75Hz	1600x1200@60Hz		1920x1080i@50Hz	
832x624@75Hz	1080P/WUXGA:		720(1440)x576i@50Hz	
1024x768@60Hz	1280x720@60Hz		1920x1080p@50Hz	
1024x768@70Hz	1280x800@60Hz		1920x1080p@24Hz	
1024x768@75Hz	1280x1024@60Hz		1920x1080p@30Hz	
1280x1024@75Hz	1400x1050@60Hz			
1152x870@75Hz	1600x1200@60Hz			
	1440x900@60Hz			
	1280x720@120Hz			
	1024x768@120Hz			

ADDITIONAL INFORMATION

True 3D video compatibility

Input resolution	HDMI 1.4a 3D Input	Input timing		
		1280x720P@50Hz	Top - and - Bottom	
		1280x720P@60Hz	Top - and - Bottom	
		1280x720P@50Hz	Frame packing	
		1280x720P@60Hz	Frame packing	
		1920x1080i@50 Hz	Side- by-Side (Half)	
		1920x1080i@60 Hz	Side- by-Side (Half)	
		1920x1080P@24 Hz	Top - and- Bottom	
	1920x1080P@24 Hz	Frame packing		
	HDMI 1.3	1920x1080i@ 50Hz	Side-by-Side(Half)	SBS mode is on
		1920x1080i@60Hz		
		1280x720P@50Hz		
		1280x720P@60Hz		
		1920x1080i@50Hz	Top-and-Bottom	TAB mode is on
		1920x1080i@60Hz		
		1280x720P@50Hz		
		1280x720P@60Hz		
480i	HQFS	3D format is Frame sequential		

Image size and projection distance

(WUXGA)

Desired Image Size						Projection Distance (C)			
Diagonal		Width		Height		Wide		Tele	
m	inch	m	inch	m	inch	m	feet	m	feet
0.76	30	0.65	25.44	0.4	15.9	0.5	1.64	0.5	1.64
0.91	36	0.78	30.53	0.48	19.08	0.6	1.97	0.6	1.97
1.02	40	0.86	33.92	0.54	21.2	0.7	2.30	0.7	2.30
1.27	50	1.08	42.4	0.67	26.5	0.9	2.95	0.9	2.95
1.52	60	1.29	50.88	0.81	31.8	1.0	3.28	1.0	3.28
1.78	70	1.51	59.36	0.94	37.1	1.2	3.94	1.2	3.94
2.03	80	1.72	67.84	1.08	42.4	1.4	4.59	1.4	4.59
2.29	90	1.94	76.32	1.21	47.7	1.5	4.92	1.5	4.92
2.54	100	2.15	84.8	1.35	53	1.7	5.58	1.7	5.58
3.05	120	2.58	101.76	1.62	63.6	2.0	6.56	2.0	6.56
3.81	150	3.23	127.2	2.02	79.5	2.6	8.53	2.6	8.53
4.57	180	3.88	152.64	2.42	95.4	3.1	10.17	3.1	10.17
5.08	200	4.31	169.6	2.69	106	3.4	11.15	3.4	11.15
6.35	250	5.38	212	3.37	132.5	4.3	14.11	4.3	14.11
7.62	300	6.46	254.4	4.04	159	5.1	16.73	5.1	16.73

ADDITIONAL INFORMATION

Lens Shift Range					
PJ lens Center to top of image				Image Shift Range	
Vertical + (Max) (A)	Vertical - (Min) (B)	Vertical Shift Range	Vertical range at any Horizontal position	Horizontal + (Right)	Horizontal - (Left)
cm	cm	cm	cm	cm	cm
48.5	40.4	8.1	7.2	6.5	6.5
58.2	48.5	9.7	8.6	7.8	7.8
64.6	53.9	10.8	9.7	8.6	8.6
80.8	67.3	13.5	12.1	10.8	10.8
96.9	80.8	16.2	14.6	12.9	12.9
113.1	94.2	18.9	16.9	15.1	15.1
129.2	107.7	21.5	19.4	17.2	17.2
145.4	121.2	24.2	21.8	19.4	19.4
161.5	134.6	26.9	24.3	21.5	21.5
193.9	161.5	32.3	29.2	25.9	25.9
242.3	201.9	40.4	36.4	32.3	32.3
290.8	242.3	48.5	43.6	38.8	38.8
323.1	269.2	53.9	48.4	43.1	43.1
403.9	336.6	67.3	60.7	53.9	53.9
484.6	403.9	80.8	72.7	64.6	64.6

Note: Zoom ratio is 1.0x.

Note: Vertical Lens Shift values are always calculated from the Center of Projection Lens. Therefore the distance 5.2 cm (2.05 inch) from the Base to the Center of Projection Lens needs to be added to each Vertical Lens Shift value.

(1080P)

Desired Image Size						Projection Distance (C)			
Diagonal		Width		Height		Wide		Tele	
m	inch	m	inch	m	inch	m	feet	m	feet
0.76	30	0.66	26.15	0.37	14.71	0.5	1.64	0.5	1.64
0.91	36	0.80	31.38	0.45	17.65	0.6	1.97	0.6	1.97
1.02	40	0.89	34.86	0.5	19.6	0.7	2.30	0.7	2.30
1.27	50	1.11	43.58	0.62	24.5	0.9	2.95	0.9	2.95
1.52	60	1.33	52.29	0.75	29.4	1.0	3.28	1.0	3.28
1.78	70	1.55	61.01	0.87	34.3	1.2	3.94	1.2	3.94
2.03	80	1.77	69.73	1	39.2	1.4	4.59	1.4	4.59
2.29	90	1.99	78.44	1.12	44.1	1.6	5.25	1.6	5.25
2.54	100	2.21	87.16	1.25	49	1.7	5.58	1.7	5.58
3.05	120	2.66	104.59	1.49	58.8	2.1	6.89	2.1	6.89
3.81	150	3.32	130.74	1.87	73.5	2.6	8.53	2.6	8.53
4.57	180	3.98	156.88	2.24	88.2	3.1	10.17	3.1	10.17
5.08	200	4.43	174.32	2.49	98.1	3.5	11.48	3.5	11.48
6.35	250	5.53	217.89	3.11	122.6	4.4	14.44	4.4	14.44
7.62	300	6.64	261.47	3.74	147.1	5.2	17.06	5.2	17.06

ADDITIONAL INFORMATION

Lens Shift Range					
PJ lens Center to top of image				Image Shift Range	
Vertical + (Max) (A)	Vertical - (Min) (B)	(D) = (A) - (B)	Vratical range at any Horizontal postion	Horizontal + (Right)	Horizontal - (Left)
cm	cm	cm	cm	cm	cm
48.6	39.2	9.3	8.3	6.6	6.6
58.3	47.1	11.2	10.1	8.0	8.0
64.8	52.3	12.5	11.3	8.9	8.9
80.9	65.4	15.6	14.0	11.1	11.1
97.1	78.5	18.7	16.9	13.3	13.3
113.3	91.5	21.8	19.6	15.5	15.5
129.5	104.6	24.9	22.5	17.7	17.7
145.7	117.7	28.0	25.2	19.9	19.9
161.9	130.8	31.1	28.1	22.1	22.1
194.3	156.9	37.4	33.5	26.6	26.6
242.8	196.1	46.7	42.1	33.2	33.2
291.4	235.4	56.0	50.4	39.9	39.9
323.8	261.5	62.3	56.0	44.3	44.3
404.7	326.9	77.8	70.0	55.4	55.4
485.7	392.3	93.4	84.2	66.4	66.4

Note: Zoom ratio is 1.0x.

Note: Vertical Lens Shift values are always calculated from the Center of Projection Lens. Therefore the distance 5.2 cm (2.05 inch) from the Base to the Center of Projection Lens needs to be added to each Vertical Lens Shift value.

(WXGA)

Desired Image Size						Projection Distance (C)			
Diagonal		Width		Height		Wide		Tele	
m	inch	m	inch	m	inch	m	feet	m	feet
0.76	30	0.65	25.44	0.4	15.9	0.5	1.64	0.5	1.64
0.91	36	0.78	30.53	0.48	19.08	0.6	1.97	0.6	1.97
1.02	40	0.86	33.92	0.54	21.2	0.7	2.30	0.7	2.30
1.27	50	1.08	42.4	0.67	26.5	0.9	2.95	0.9	2.95
1.52	60	1.29	50.88	0.81	31.8	1.1	3.61	1.1	3.61
1.78	70	1.51	59.36	0.94	37.1	1.3	4.27	1.3	4.27
2.03	80	1.72	67.84	1.08	42.4	1.4	4.59	1.4	4.59
2.29	90	1.94	76.32	1.21	47.7	1.6	5.25	1.6	5.25
2.54	100	2.15	84.8	1.35	53	1.8	5.91	1.8	5.91
3.05	120	2.58	101.76	1.62	63.6	2.1	6.89	2.1	6.89
3.81	150	3.23	127.2	2.02	79.5	2.7	8.86	2.7	8.86
4.57	180	3.88	152.64	2.42	95.4	3.2	10.50	3.2	10.50
5.08	200	4.31	169.6	2.69	106	3.6	11.81	3.6	11.81
6.35	250	5.38	212	3.37	132.5	4.5	14.76	4.5	14.76
7.62	300	6.46	254.4	4.04	159	5.4	17.72	5.4	17.72

ADDITIONAL INFORMATION

Lens Shift Range					
PJ lens Center to top of image				Image Shift Range	
Vertical + (Max) (A)	Vertical - (Min) (B)	(D) = (A) - (B)	Vertical range at any Horizontal position	Horizontal + (Right)	Horizontal - (Left)
cm	cm	cm	cm	cm	cm
50.5	42.4	8.1	7.2	6.5	6.5
60.6	50.9	9.7	8.6	7.8	7.8
67.3	56.5	10.8	9.7	8.6	8.6
84.1	70.7	13.5	12.1	10.8	10.8
101.0	84.8	16.2	14.6	12.9	12.9
117.8	99.0	18.8	16.9	15.1	15.1
134.6	113.1	21.5	19.4	17.2	17.2
151.5	127.2	24.2	21.8	19.4	19.4
168.3	141.4	26.9	24.3	21.5	21.5
201.9	169.6	32.3	29.2	25.9	25.9
252.4	212.0	40.4	36.4	32.3	32.3
302.9	254.4	48.5	43.6	38.8	38.8
336.6	282.7	53.9	48.4	43.1	43.1
420.7	353.4	67.3	60.7	53.9	53.9
504.8	424.1	80.8	72.7	64.6	64.6

Note: Zoom ratio is 1.0x.

Note: Vertical Lens Shift values are always calculated from the Center of Projection Lens. Therefore the distance 5.2 cm (2.05 inch) from the Base to the Center of Projection Lens needs to be added to each Vertical Lens Shift value.

(XGA)

Desired Image Size						Projection Distance (C)			
Diagonal		Width		Height		Wide		Tele	
m	inch	m	inch	m	inch	m	feet	m	feet
0.76	30	0.61	24	0.46	18	0.5	1.64	0.5	1.64
1.02	40	0.81	32	0.61	24	0.7	2.30	0.7	2.30
1.27	50	1.02	40	0.76	30	0.8	2.62	0.8	2.62
1.52	60	1.22	48	0.91	36	1.0	3.28	1.0	3.28
1.78	70	1.42	56	1.07	42	1.2	3.94	1.2	3.94
2.03	80	1.63	64	1.22	48	1.3	4.27	1.3	4.27
2.29	90	1.83	72	1.37	54	1.5	4.92	1.5	4.92
2.54	100	2.03	80	1.52	60	1.7	5.58	1.7	5.58
3.05	120	2.44	96	1.83	72	2.0	6.56	2.0	6.56
3.81	150	3.05	120	2.29	90	2.5	8.20	2.5	8.20
4.57	180	3.66	144	2.74	108	3.0	9.84	3.0	9.84
5.08	200	4.06	160	3.05	120	3.3	10.83	3.3	10.83
6.35	250	5.08	200	3.81	150	4.2	13.78	4.2	13.78
7.62	300	6.10	240	4.57	180	5.0	16.40	5.0	16.40

ADDITIONAL INFORMATION

Lens Shift Range					
PJ lens Center to top of image				Image Shift Range	
Vertical + (Max) (A)	Vertical - (Min) (B)	(D) = (A) - (B)	Vratical range at any Horizontal postion	Horizontal + (Right)	Horizontal - (Left)
cm	cm	cm	cm	cm	cm
48.0	43.4	4.6	4.1	6.1	6.1
64.0	57.9	6.1	5.5	8.1	8.1
80.0	72.4	7.6	6.8	10.2	10.2
96.0	86.9	9.1	8.2	12.2	12.2
112.0	101.4	10.7	9.6	14.2	14.2
128.0	115.8	12.2	11.0	16.3	16.3
144.0	130.3	13.7	12.3	18.3	18.3
160.0	144.8	15.2	13.7	20.3	20.3
192.0	173.7	18.3	16.5	24.4	24.4
240.0	217.2	22.9	20.6	30.5	30.5
288.0	260.6	27.4	24.7	36.6	36.6
320.0	289.6	30.5	27.5	40.6	40.6
400.1	362.0	38.1	34.3	50.8	50.8
480.1	434.3	45.7	41.1	61.0	61.0

Note: Zoom ratio is 1.0x.

Note: Vertical Lens Shift values are always calculated from the Center of Projection Lens. Therefore the distance 5.2 cm (2.05 inch) from the Base to the Center of Projection Lens needs to be added to each Vertical Lens Shift value.

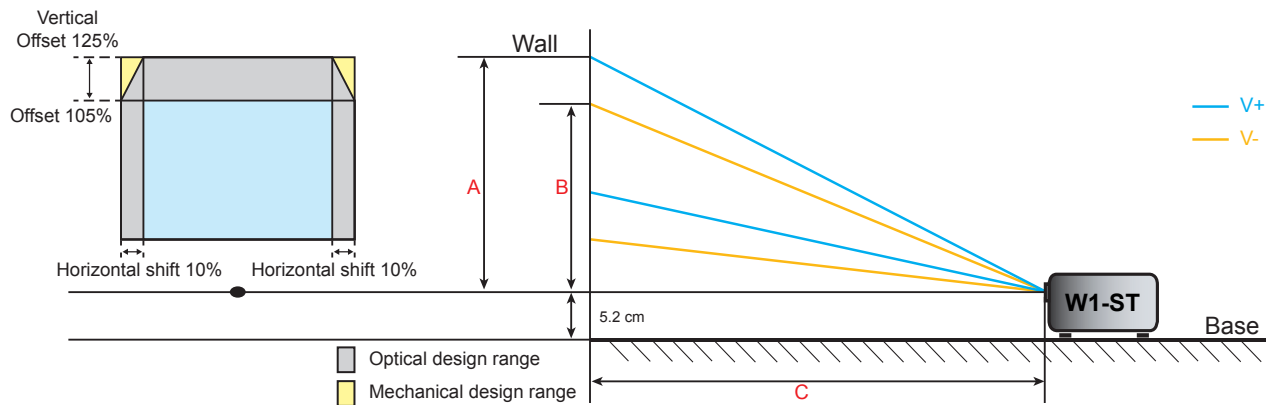

ADDITIONAL INFORMATION

Determining the lens shift center position

Horizontal Lens Shift Center

1. Adjust the V. Shift until the image reaches the maximum range on the bottom end.

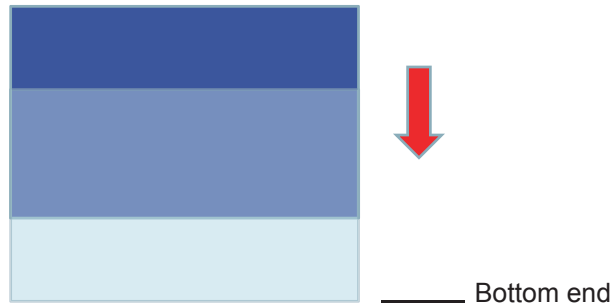

2. Adjust the H. Shift until the image reaches the maximum shift range towards the left.

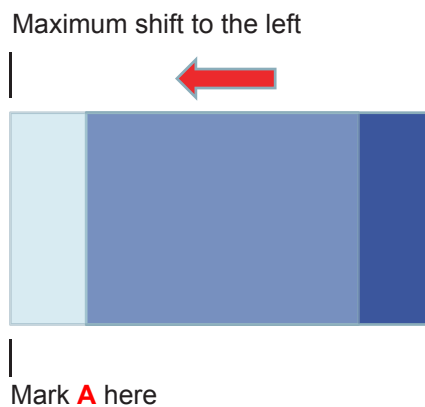

3. Adjust the H. Shift until the image reaches the maximum shift range to the right.

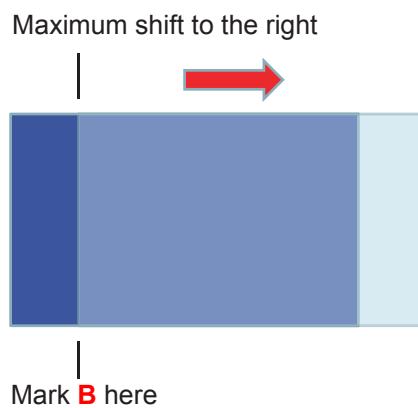

4. Measure the distance between Mark A and Mark B, then divide it by 2 and position the image back to Mark A/B to the left. The image will be at the center of its Horizontal shift.

ADDITIONAL INFORMATION

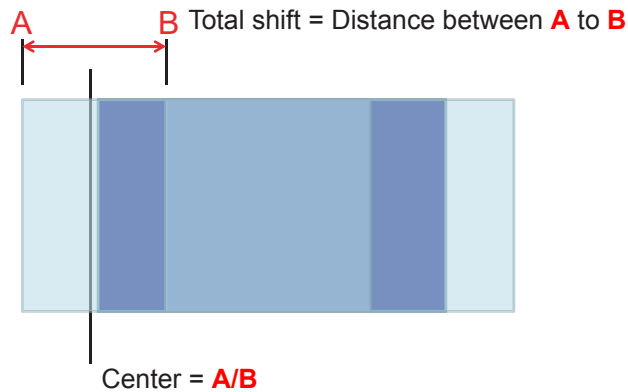

Vertical Lens Shift Center

1. Image must be at the center of its Horizontal shift before adjusting the image to the center of its Vertical shift.



2. Adjust the V. Shift until the image reaches the maximum shift range towards the bottom.

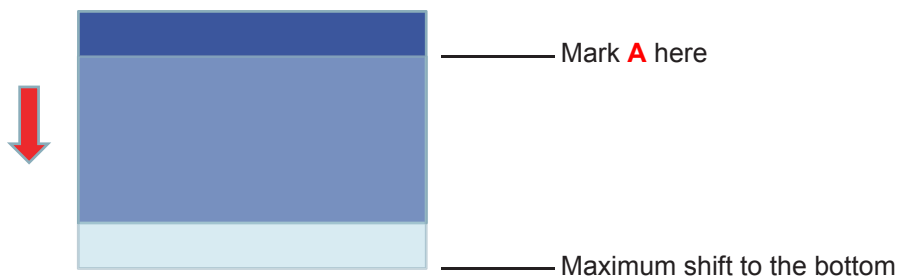

3. Adjust the V. Shift until the image reaches the maximum shift range to the top.

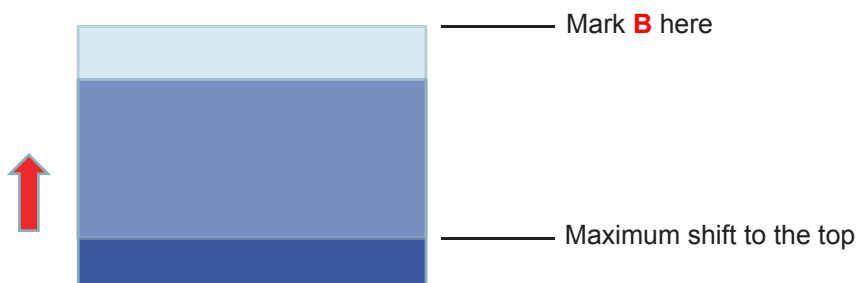

4. Measure the distance between Mark **A** and Mark **B**, then divide it by 2 and position the image back to Mark **A/B** to the bottom. The image will be at the center of its Vertical shift.

ADDITIONAL INFORMATION

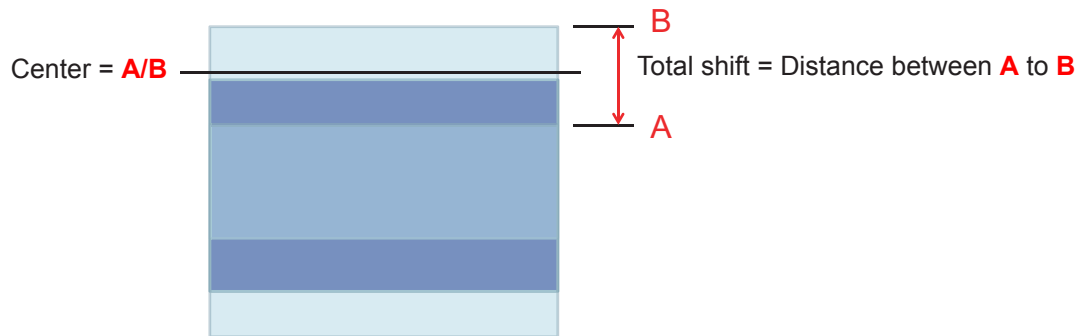

ADDITIONAL INFORMATION

Projector dimensions and ceiling mount installation

1. To prevent damage to your projector, please use the Optoma ceiling mount.
2. If you wish to use a third party ceiling mount kit, please ensure the screws used to attach a mount to the projector meet the following specifications:
 - Screw type: M4*3
 - Minimum screw length: 10mm

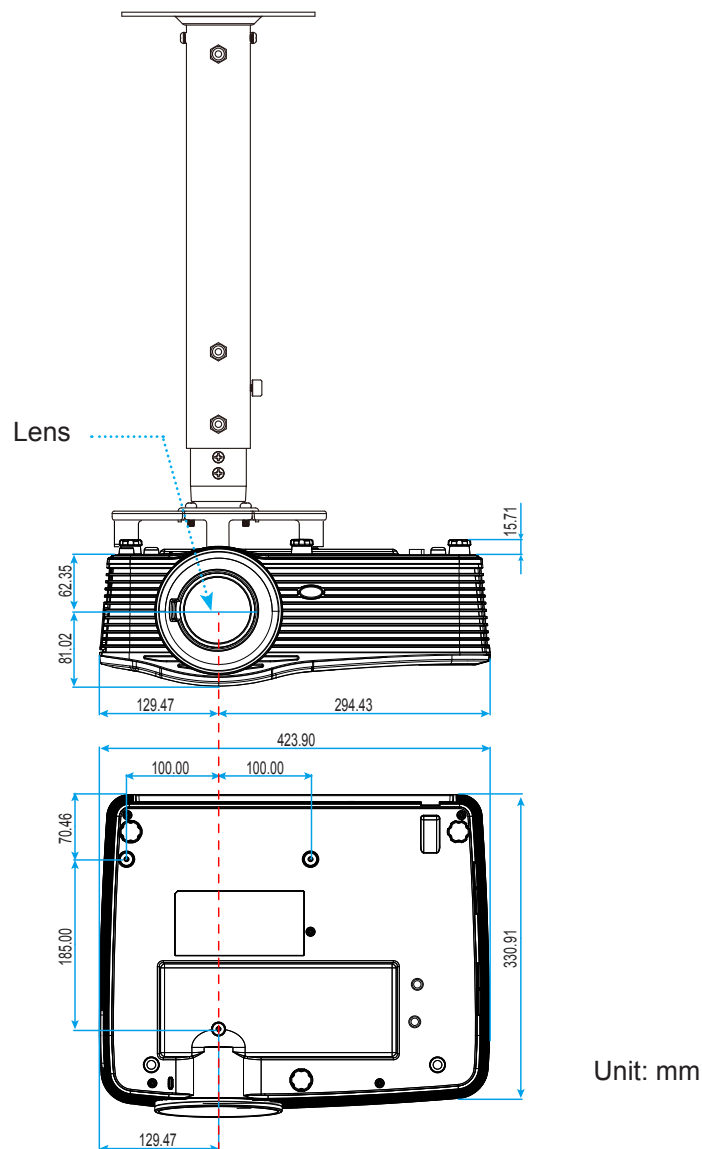

Note: Please note that damage resulting from incorrect installation will void the warranty.



Warning:

- If you buy a ceiling mount from another company, please be sure to use the correct screw size. Screw size will vary depending on the thickness of the mounting plate.
- Be sure to keep at least 10 cm gap between the ceiling and the bottom of the projector.
- Avoid installing the projector near a heat source.

ADDITIONAL INFORMATION

RS232 protocol function list

Baud Rate : 9600

Data Bits: 8

Parity: None

Stop Bits: 1

Flow Control : None

UART16550 FIFO: Disable

Projector Return (Pass): P

Projector Return (Fail): F

XX=01-99, projector's ID, XX=00 is for all projectors

Note: There is a <CR> after all ASCII commands 0D is the HEX code for <CR> in ASCII code.

SEND to projector			
232 ASCII Code	HEX Code	Function	Description
~XX00 1	7E 30 30 30 30 20 31 0D	Power ON	
~XX00 0	7E 30 30 30 30 20 30 0D	Power OFF	(0/2 for backward compatible)
~XX00 1	7E 30 30 30 30 20 31 20	Power ON with Password	~nnnn = ~0000 (a=7E 30 30 30 30)
~nnnn	a 0D		~9999 (a=7E 39 39 39 39)
~XX01 1	7E 30 30 30 31 20 31 0D	Resync	
~XX02 1	7E 30 30 30 32 20 31 0D	AV Mute	On
~XX02 0	7E 30 30 30 32 20 30 0D		Off (0/2 for backward compatible)
~XX03 1	7E 30 30 30 33 20 31 0D	Mute	On
~XX03 0	7E 30 30 30 33 20 30 0D		Off (0/2 for backward compatible)
~XX04 1	7E 30 30 30 34 20 31 0D	Freeze	
~XX04 0	7E 30 30 30 34 20 30 0D	Unfreeze	(0/2 for backward compatible)
~XX05 1	7E 30 30 30 35 20 31 0D	Zoom Plus	
~XX06 1	7E 30 30 30 36 20 31 0D	Zoom Minus	
~XX12 1	7E 30 30 31 32 20 31 0D	Direct Source Commands	HDMI1
~XX12 15	7E 30 30 31 32 20 31 35 0D		HDMI2
~XX12 20	7E 30 30 31 32 20 32 30 0D		Displayport
~XX12 5	7E 30 30 31 32 20 35 0D		VGA1
~XX12 8	7E 30 30 31 32 20 38 0D		VGA1 Component
~XX12 6	7E 30 30 31 32 20 36 0D		VGA 2
~XX12 13	7E 30 30 31 32 20 31 33 0D		VGA2 Component
~XX12 9	7E 30 30 31 32 20 39 0D		S-Video
~XX12 10	7E 30 30 31 32 20 31 30 0D		Video
~XX12 21	7E 30 30 31 32 20 32 31 0D		HDBaseT (only exists in "T" SKU)
~XX20 1	7E 30 30 32 30 20 31 0D	Display Mode	Presentation
~XX20 2	7E 30 30 32 30 20 32 0D		Bright
~XX20 3	7E 30 30 32 30 20 33 0D		Movie
~XX20 4	7E 30 30 32 30 20 34 0D		sRGB
~XX20 5	7E 30 30 32 30 20 35 0D		User
~XX20 7	7E 30 30 32 30 20 37 0D		Blackboard
~XX20 13	7E 30 30 32 30 21 33 0D		DICOM SIM.
~XX20 9	7E 30 30 32 30 20 39 0D		3D
~XX21 n	7E 30 30 32 31 20 a 0D	Brightness	n = -50 (a=2D 35 30) ~ 50 (a=35 30)
~XX22 n	7E 30 30 32 32 20 a 0D	Contrast	n = -50 (a=2D 35 30) ~ 50 (a=35 30)
~XX23 n	7E 30 30 32 33 20 a 0D	Sharpness	n = 1 (a=31) ~ 15 (a=31 35)
~XX45 n	7E 30 30 34 34 20 a 0D	Color (Saturation)	n = -50 (a=2D 35 30) ~ 50 (a=35 30)
~XX44 n	7E 30 30 34 35 20 a 0D	Tint	n = -50 (a=2D 35 30) ~ 50 (a=35 30)
~XX34 n	7E 30 30 33 34 20 a 0D	BrilliantColor™	n = 1 (a=31) ~ 10 (a=31 30)
~XX191 1	7E 30 30 31 39 31 20 31 0D	DynamicBlack	On
~XX191 0	7E 30 30 31 39 31 20 30 0D		Off(0/2 backward compatible)
~XX35 1	7E 30 30 33 35 20 31 0D	Gamma	Film
~XX35 3	7E 30 30 33 35 20 33 0D		Graphics
~XX35 7	7E 30 30 33 35 20 37 0D		2.2
~XX35 5	7E 30 30 33 35 20 35 0D		1.8
~XX35 6	7E 30 30 33 35 20 36 0D		2.0
~XX35 8	7E 30 30 33 35 20 38 0D		2.6
~XX35 10	7E 30 30 33 35 20 31 30 0D		Blackboard
~XX35 11	7E 30 30 33 35 20 31 31 0D		DICOM

ADDITIONAL INFORMATION

SEND to projector			
232 ASCII Code	HEX Code	Function	Description
~XX36 4	7E 30 30 33 36 20 34 0D	Color Temp.	Warm
~XX36 1	7E 30 30 33 36 20 31 0D		Standard
~XX36 2	7E 30 30 33 36 20 32 0D		Cool
~XX36 3	7E 30 30 33 36 20 33 0D		Cold
~XX37 1	7E 30 30 33 37 20 31 0D	Color Space	Auto
~XX37 2	7E 30 30 33 37 20 32 0D		RGB\ RGB(0-255)
~XX37 3	7E 30 30 33 37 20 33 0D		YUV
~XX37 4	7E 30 30 33 37 20 34 0D		RGB(16 - 235)
~XX24 n	7E 30 30 32 34 20 a 0D	RGB Gain/Bias	Red Gain n = -50 (a=2D 35 30) ~ 50 (a=35 30)
~XX25 n	7E 30 30 32 35 20 a 0D		Green Gain n = -50 (a=2D 35 30) ~ 50 (a=35 30)
~XX26 n	7E 30 30 32 36 20 a 0D		Blue Gain n = -50 (a=2D 35 30) ~ 50 (a=35 30)
~XX27 n	7E 30 30 32 37 20 a 0D		Red Bias n = -50 (a=2D 35 30) ~ 50 (a=35 30)
~XX28 n	7E 30 30 32 38 20 a 0D		Green Bias n = -50 (a=2D 35 30) ~ 50 (a=35 30)
~XX29 n	7E 30 30 32 39 20 a 0D		Blue Bias n = -50 (a=2D 35 30) ~ 50 (a=35 30)
~XX517 1	7E 30 30 35 31 37 20 31 0D	RGB Gain/Bias Reset	Reset
~XX509	7E 30 30 35 30 39 20 0D	Image Settings Reset	Reset
~XX327 n	7E 30 30 33 32 37 20 a 0D	Color Matching	Red Hue n = -50 (a=2D 35 30) ~ 50 (a=35 30)
~XX333 n	7E 30 30 33 33 33 20 a 0D		Red Saturation n = -50 (a=2D 35 30) ~ 50 (a=35 30)
~XX339 n	7E 30 30 33 33 39 20 a 0D		Red Gain n = -50 (a=2D 35 30) ~ 50 (a=35 30)
~XX328 n	7E 30 30 33 32 38 20 a 0D		Green Hue n = -50 (a=2D 35 30) ~ 50 (a=35 30)
~XX334 n	7E 30 30 33 33 34 20 a 0D		Green Saturation n = -50 (a=2D 35 30) ~ 50 (a=35 30)
~XX340 n	7E 30 30 33 34 30 20 a 0D		Green Gain n = -50 (a=2D 35 30) ~ 50 (a=35 30)
~XX329 n	7E 30 30 33 32 39 20 a 0D		Blue Hue n = -50 (a=2D 35 30) ~ 50 (a=35 30)
~XX335 n	7E 30 30 33 33 35 20 a 0D		Blue Saturation n = -50 (a=2D 35 30) ~ 50 (a=35 30)
~XX341 n	7E 30 30 33 34 31 20 a 0D		Blue Gain n = -50 (a=2D 35 30) ~ 50 (a=35 30)
~XX330 n	7E 30 30 33 33 30 20 a 0D		Cyan Hue n = -50 (a=2D 35 30) ~ 50 (a=35 30)
~XX336 n	7E 30 30 33 33 36 20 a 0D		Cyan Saturation n = -50 (a=2D 35 30) ~ 50 (a=35 30)
~XX342 n	7E 30 30 33 34 32 20 a 0D		Cyan Gain n = -50 (a=2D 35 30) ~ 50 (a=35 30)
~XX331 n	7E 30 30 33 33 31 20 a 0D		Yellow Hue n = -50 (a=2D 35 30) ~ 50 (a=35 30)
~XX337 n	7E 30 30 33 33 37 20 a 0D		Yellow Saturation n = -50 (a=2D 35 30) ~ 50 (a=35 30)
~XX343 n	7E 30 30 33 34 33 20 a 0D		Yellow Gain n = -50 (a=2D 35 30) ~ 50 (a=35 30)
~XX332 n	7E 30 30 33 33 32 20 a 0D		Magenta Hue n = -50 (a=2D 35 30) ~ 50 (a=35 30)
~XX338 n	7E 30 30 33 33 38 20 a 0D		Magenta Saturation n = -50 (a=2D 35 30) ~ 50 (a=35 30)
~XX344 n	7E 30 30 33 34 34 20 a 0D		Magenta Gain n = -50 (a=2D 35 30) ~ 50 (a=35 30)
~XX345 n	7E 30 30 33 34 35 20 a 0D	White	Red n = -50 (a=2D 35 30) ~ 50 (a=35 30)
~XX346 n	7E 30 30 33 34 36 20 a 0D		Green n = -50 (a=2D 35 30) ~ 50 (a=35 30)
~XX347 n	7E 30 30 33 34 37 20 a 0D		Blue n = -50 (a=2D 35 30) ~ 50 (a=35 30)
~XX215 1	7E 30 30 32 31 35 20 31 0D	Reset	
~XX73 n	7E 30 30 37 33 20 a 0D	Signal (RGB)	Frequency n = -10 (a=2D 35) ~ 10 (a=35) By signal
~XX91 1	7E 30 30 39 31 20 31 0D		Automatic On
~XX91 0	7E 30 30 39 31 20 30 0D		Off
~XX74 n	7E 30 30 37 34 20 a 0D		Phase n = 0 (a=30) ~ 31 (a=33 31) By signal
~XX75 n	7E 30 30 37 35 20 a 0D		H. Position n = -5 (a=2D 35) ~ 5 (a=35) By timing
~XX76 n	7E 30 30 37 36 20 a 0D		V. Position n = -5 (a=2D 35) ~ 5 (a=35) By timing
~XX200 n	7E 30 30 32 30 30 20 a 0D	Signal(Video)	White Level n = 0 (a=30) ~ 31 (a=33 31)
~XX201 n	7E 30 30 32 30 31 20 a 0D		Black Level n = -5 (a=2D 35) ~ 5 (a=35)
~XX204 1	7E 30 30 32 30 30 24 20 31 0D		0 IRE
~XX204 0	7E 30 30 32 30 30 24 20 30 0D		7.5 IRE
~XX60 1	7E 30 30 36 30 20 31 0D	Format	4:3
~XX60 2	7E 30 30 36 30 20 32 0D		16:9
~XX60 3	7E 30 30 36 30 20 33 0D		16:10(WXGA, WUXGA)

ADDITIONAL INFORMATION

SEND to projector			
232 ASCII Code	HEX Code	Function	Description
~XX60 5	7E 30 30 36 30 20 35 0D		LBX
~XX60 6	7E 30 30 36 30 20 36 0D		Native
~XX60 7	7E 30 30 36 30 20 37 0D		Auto
~XX61 n	7E 30 30 36 31 20 a 0D	Edge mask	n = 0 (a=30) ~ 10 (a=31 30)
~XX62 n	7E 30 30 36 32 20 a 0D	Zoom	n = -5 (a=2D 35) ~ 25 (a=32 35)
~XX63 n	7E 30 30 36 33 20 a 0D	H Image Shift	n = -100 (a=2D 31 30 30) ~ 100 (a=31 30 30)
~XX64 n	7E 30 30 36 34 20 a 0D	V Image Shift	n = -100 (a=2D 31 30 30) ~ 100 (a=31 30 30)
~XX65 n	7E 30 30 36 35 20 a 0D	H Keystone	n = -30 (a=2D 33 30) ~ 30 (a=33 30)
~XX66 n	7E 30 30 36 36 20 a 0D	V Keystone	n = -30 (a=2D 33 30) ~ 30 (a=33 30)
~XX69 1	7E 30 30 36 39 20 31 0D	Auto V.Keystone	On
~XX69 0	7E 30 30 36 39 20 30 0D	Auto V. Keystone	Off
~XX59 1	7E 30 30 35 39 20 31 0D	Four corners (Top-Left)	Right+
~XX59 2	7E 30 30 35 39 20 32 0D		Left+
~XX59 3	7E 30 30 35 39 20 33 0D		Up+
~XX59 4	7E 30 30 35 39 20 34 0D		Down+
~XX59 5	7E 30 30 35 39 20 35 0D	(Top-Right)	Right+
~XX59 6	7E 30 30 35 39 20 36 0D		Left+
~XX59 7	7E 30 30 35 39 20 37 0D		Up+
~XX59 8	7E 30 30 35 39 20 38 0D		Down+
~XX59 9	7E 30 30 35 39 20 39 0D	(Bottom-Left)	Right+
~XX59 10	7E 30 30 35 39 20 31 30 0D		Left+
~XX59 11	7E 30 30 35 39 20 31 31 0D		Up+
~XX59 12	7E 30 30 35 39 20 31 32 0D		Down+
~XX59 13	7E 30 30 35 39 20 31 33 0D	(Bottom-Right)	Right+
~XX59 14	7E 30 30 35 39 20 31 34 0D		Left+
~XX59 15	7E 30 30 35 39 20 31 35 0D		Up+
~XX59 16	7E 30 30 35 39 20 31 36 0D		Down+
~XX516	7E 30 30 35 31 36 20 0D	Four corners reset	Reset
~XX506 0	7E 30 30 35 30 36 20 30 0D	Wall Color	Off
~XX506 2	7E 30 30 35 30 36 20 32 0D		Light Yellow
~XX506 3	7E 30 30 35 30 36 20 33 0D		Light Green
~XX506 4	7E 30 30 35 30 36 20 34 0D		Light Blue
~XX506 5	7E 30 30 35 30 36 20 35 0D		Pink
~XX506 6	7E 30 30 35 30 36 20 36 0D		Gray
~XX230 1	7E 30 30 32 33 30 20 31 0D	3D Mode	DLP-Link
~XX230 3	7E 30 30 32 33 30 20 31 0D		VESA 3D
~XX230 0	7E 30 30 32 33 30 20 30 0D		Off (0/2 for backward compatible)
~XX400 0	7E 30 30 34 30 30 20 30 0D	3D->2D	3D
~XX400 1	7E 30 30 34 30 30 20 31 0D		L
~XX400 2	7E 30 30 34 30 30 20 32 0D		R
~XX405 0	7E 30 30 34 30 35 20 30 0D	3D Format	Auto
~XX405 1	7E 30 30 34 30 35 20 31 0D		SBS
~XX405 2	7E 30 30 34 30 35 20 32 0D		Top and Bottom
~XX405 3	7E 30 30 34 30 35 20 33 0D		Frame sequential
~XX231 0	7E 30 30 32 33 31 20 30 0D	3D Sync Invert	On
~XX231 1	7E 30 30 32 33 31 20 31 0D	3D Sync Invert	Off
~XX70 1	7E 30 30 37 30 20 31 0D	Language	English
~XX70 2	7E 30 30 37 30 20 32 0D		German
~XX70 3	7E 30 30 37 30 20 33 0D		French
~XX70 4	7E 30 30 37 30 20 34 0D		Italian
~XX70 5	7E 30 30 37 30 20 35 0D		Spanish
~XX70 6	7E 30 30 37 30 20 36 0D		Portuguese
~XX70 7	7E 30 30 37 30 20 37 0D		Polish
~XX70 8	7E 30 30 37 30 20 38 0D		Dutch
~XX70 9	7E 30 30 37 30 20 39 0D		Swedish

ADDITIONAL INFORMATION

SEND to projector				
232 ASCII Code	HEX Code	Function	Description	
~XX70 10	7E 30 30 37 30 20 31 30 0D		Norwegian/Danish	
~XX70 11	7E 30 30 37 30 20 31 31 0D		Finnish	
~XX70 12	7E 30 30 37 30 20 31 32 0D		Greek	
~XX70 13	7E 30 30 37 30 20 31 33 0D		Traditional Chinese	
~XX70 14	7E 30 30 37 30 20 31 34 0D		Simplified Chinese	
~XX70 15	7E 30 30 37 30 20 31 35 0D		Japanese	
~XX70 16	7E 30 30 37 30 20 31 36 0D		Korean	
~XX70 17	7E 30 30 37 30 20 31 37 0D		Russian	
~XX70 18	7E 30 30 37 30 20 31 38 0D		Hungarian	
~XX70 19	7E 30 30 37 30 20 31 39 0D		Czechoslovak	
~XX70 20	7E 30 30 37 30 20 32 30 0D		Arabic	
~XX70 21	7E 30 30 37 30 20 32 31 0D		Thai	
~XX70 22	7E 30 30 37 30 20 32 32 0D		Turkish	
~XX70 23	7E 30 30 37 30 20 32 33 0D		Farsi	
~XX70 25	7E 30 30 37 30 20 32 33 0D		Vietnamese	
~XX70 26	7E 30 30 37 30 20 32 33 0D		Indonesian	
~XX70 27	7E 30 30 37 30 20 32 33 0D		Romanian	
~XX71 1	7E 30 30 37 31 20 31 0D	Projection	Front-Desktop	
~XX71 2	7E 30 30 37 31 20 32 0D		Rear-Desktop	
~XX71 3	7E 30 30 37 31 20 33 0D		Front-Ceiling	
~XX71 4	7E 30 30 37 31 20 34 0D		Rear-Ceiling	
~XX90 1	7E 30 30 39 31 20 31 0D	Screen Type (WXGA/WUXGA)	16:10	
~XX90 0	7E 30 30 39 31 20 30 0D		16:9	
~XX72 1	7E 30 30 37 32 20 31 0D	Menu Location	Top Left	
~XX72 2	7E 30 30 37 32 20 32 0D		Top Right	
~XX72 3	7E 30 30 37 32 20 33 0D		Centre	
~XX72 4	7E 30 30 37 32 20 34 0D		Bottom Left	
~XX72 5	7E 30 30 37 32 20 35 0D		Bottom Right	
~XX77 n	7E 30 30 37 37 20 aabbcc 0D	Security	Security Timer	Month/Day/Hour n = mm/dd/hh mm= 00 (aa=30 30) ~ 12 (aa=31 32) dd = 00 (bb=30 30) ~ 30 (bb=33 30) hh= 00 (cc=30 30) ~ 24 (cc=32 34)
~XX78 1	7E 30 30 37 38 20 31 0D	Security	On	
~XX78 0	7E 30 30 37 38 20 30 20		Off (0/2 for backward compatible)	
~nnnn	a 0D		~nnnn = ~0000 (a=7E 30 30 30 30) ~9999 (a=7E 39 39 39 39)	
~XX79 n	7E 30 30 37 39 20 a 0D	Projector ID	n = 00 (a=30 30) ~ 99 (a=39 39)	
~XX310 0	7E 30 33 31 30 20 30 0D	Internal Speaker	Off	
~XX310 1	7E 30 33 31 30 20 31 0D		On	
~XX80 1	7E 30 30 38 30 20 31 0D	Mute	On	
~XX80 0	7E 30 30 38 30 20 30 0D		Off (0/2 for backward compatible)	
~XX81 n	7E 30 30 38 31 20 a 0D	Volume(Audio)		n = 0 (a=30) ~ 10 (a=31 30)
~XX93 n	7E 30 30 39 33 20 a 0D	Volume(Mic)		n = 0 (a=30) ~ 10 (a=31 30)
~XX89 0	7E 30 30 38 39 20 30 0D	Audio Input	Default	
~XX89 1	7E 30 30 38 39 20 31 0D		Audio1	
~XX89 3	7E 30 30 38 39 20 33 0D		Audio2	
~XX89 4	7E 30 30 38 39 20 34 0D		Audio3	
~XX82 1	7E 30 30 38 32 20 31 0D	Logo	Default	
~XX82 2	7E 30 30 38 32 20 32 0D		User	
~XX82 3	7E 30 30 38 32 20 33 0D		Neutral	
~XX83 1	7E 30 30 38 33 20 31 0D	Logo Capture		
~XX88 0	7E 30 30 38 38 20 30 0D	Closed Captioning	Off	
~XX88 1	7E 30 30 38 38 20 31 0D		cc1	
~XX88 2	7E 30 30 38 38 20 32 0D		cc2	
~XX521 0	7E 30 30 35 32 31 20 30 0D	Wireless	Off (0/2 for backward compatible)	
~XX521 1	7E 30 30 35 32 31 20 31 0D	Wireless	On	
~XX454 0	7E 30 30 34 35 34 20 300D	Crestron	Off	

ADDITIONAL INFORMATION

SEND to projector			
232 ASCII Code	HEX Code	Function	Description
~XX454 1	7E 30 30 34 35 34 20 31 0D		On
~XX455 0	7E 30 30 34 35 35 20 30 0D	Extron	Off
~XX455 1	7E 30 30 34 35 35 20 31 0D		On
~XX456 0	7E 30 30 34 35 36 20 30 0D	PJLink	Off
~XX456 1	7E 30 30 34 35 36 20 31 0D		On
~XX457 0	7E 30 30 34 35 37 20 30 0D	AMX Device Discovery	Off
~XX457 1	7E 30 30 34 35 37 20 31 0D		On
~XX458 0	7E 30 30 34 35 38 20 30 0D	Telnet	Off
~XX458 1	7E 30 30 34 35 38 20 31 0D		On
~XX459 0	7E 30 30 34 35 38 20 30 0D	HTTP	Off
~XX459 1	7E 30 30 34 35 38 20 31 0D		On
~XX39 1	7E 30 30 33 39 20 31 0D	Input Source	HDMI1
~XX39 7	7E 30 30 33 39 20 37 0D		HDMI2
~XX39 15	7E 30 30 33 39 20 31 35 0D		Displayport
~XX39 5	7E 30 30 33 39 20 35 0D		VGA1
~XX39 6	7E 30 30 33 39 20 36 0D		VGA2
~XX39 9	7E 30 30 33 39 20 39 0D		S-Video
~XX39 10	7E 30 30 33 39 20 31 30 0D		Video
~XX100 1	7E 30 30 31 30 30 20 31 0D	Source Lock	On
~XX100 0	7E 30 30 31 30 30 20 30 0D		Off (0/2 for backward compatible)
~XX101 1	7E 30 30 31 30 31 20 31 0D	High Altitude	On
~XX101 0	7E 30 30 31 30 31 20 30 0D		Off (0/2 for backward compatible)
~XX102 1	7E 30 30 31 30 32 20 31 0D	Information Hide	On
~XX102 0	7E 30 30 31 30 32 20 30 0D		Off (0/2 for backward compatible)
~XX103 1	7E 30 30 31 30 33 20 31 0D	Keypad Lock	On
~XX103 0	7E 30 30 31 30 33 20 30 0D		Off (0/2 for backward compatible)
~XX348 1	7E 30 30 33 34 38 20 31 0D	Display Mode Lock	On
~XX348 0	7E 30 30 33 34 38 20 30 0D		Off (0/2 for backward compatible)
~XX195 0	7E 30 30 31 39 35 20 30 0D	Test Pattern	None
~XX195 1	7E 30 30 31 39 35 20 31 0D		Grid
~XX195 2	7E 30 30 31 39 35 20 32 0D		White Pattern
~XX104 1	7E 30 30 31 30 34 20 31 0D	Background Color	Blue
~XX104 2	7E 30 30 31 30 34 20 32 0D		Black
~XX104 3	7E 30 30 31 30 34 20 33 0D		Red
~XX104 4	7E 30 30 31 30 34 20 34 0D		Green
~XX104 5	7E 30 30 31 30 34 20 35 0D		White
~XX11 0	7E 30 30 31 31 20 30 0D	IR Function	Off
~XX11 1	7E 30 30 31 31 20 31 0D		On
~XX11 2	7E 30 30 31 31 20 32 0D		Front
~XX11 3	7E 30 30 31 31 20 33 0D		Top
~XX350 n	7E 30 30 33 35 30 20 a 0D	Remote Code	n = 00 (a=30 30) ~ 99 (a=39 39)
~XX192 0	7E 30 30 31 39 32 20 30 0D	12V Trigger	Off
~XX192 1	7E 30 30 31 39 32 20 31 0D		On
~XX105 1	7E 30 30 31 30 35 20 31 0D	Advanced	Direct Power On On
~XX105 0	7E 30 30 31 30 35 20 30 0D		Off (0/2 for backward compatible)
~XX113 0	7E 30 30 31 31 33 20 30 0D		Signal Power On Off
~XX113 1	7E 30 30 31 31 33 20 31 0D		On
~XX106 n	7E 30 30 31 30 36 20 a 0D		Auto Power Off n = 0 (a=30) ~ 180 (a=31 38 30) (min) (5 minutes for each step).
~XX107 n	7E 30 30 31 30 37 20 a 0D		Sleep Timer (min) n = 0 (a=30) ~ 990 (a=39 39 30) (10 minutes for each step).
~XX507 1	7E 30 30 35 30 37 20 31 0D		Sleep Timer Repeat On
~XX507 0	7E 30 30 35 30 37 20 30 0D		Off
~XX115 1	7E 30 30 31 31 35 20 31 0D		Quick Resume On
~XX115 0	7E 30 30 31 31 35 20 30 0D		Off (0/2 for backward compatible)
~XX114 1	7E 30 30 31 31 34 20 31 0D		Power Mode(Standby) Eco.(≤0.5W)
~XX114 0	7E 30 30 31 31 34 20 30 0D		Active (0/2 for backward compatible)

ADDITIONAL INFORMATION

SEND to projector				
232 ASCII Code	HEX Code	Function	Description	
~XX109 1	7E 30 30 31 30 39 20 31 0D	Lamp Reminder	On	
~XX109 0	7E 30 30 31 30 39 20 30 0D		Off (0/2 for backward compatible)	
~XX110 1	7E 30 30 31 31 30 20 31 0D	Lamp Mode	Bright	
~XX110 2	7E 30 30 31 31 30 20 32 0D		Eco	
~XX110 5	7E 30 30 31 31 30 20 35 0D		Power	
~XX326 0	7E 30 30 33 32 36 20 30 0D	Power /100%		
~XX326 1	7E 30 30 33 32 36 20 31 0D	Power /95%		
~XX326 2	7E 30 30 33 32 36 20 32 0D	Power /90%		
~XX326 3	7E 30 30 33 32 36 20 33 0D	Power /85%		
~XX326 4	7E 30 30 33 32 36 20 34 0D	Power /80%		
~XX111 1	7E 30 30 31 31 31 20 31 0D	Lamp Reset	Yes	
~XX320 1	7E 30 30 33 32 30 20 31 0D	Optional Filter Installed	Yes	
~XX320 0	7E 30 30 33 32 30 20 30 0D		No (0/2 for backward compatible)	
~XX322 0	7E 30 30 33 32 32 20 30 0D	Filter Reminder	Off	
~XX322 1	7E 30 30 33 32 32 20 31 0D		300 hrs	
~XX322 2	7E 30 30 33 32 32 20 32 0D		500 hrs	
~XX322 3	7E 30 30 33 32 32 20 33 0D		800 hrs	
~XX322 4	7E 30 30 33 32 32 20 34 0D		1000 hrs	
~XX323 1	7E 30 30 33 32 33 20 31 0D	Filter Reset	Yes	
~XX313 1	7E 30 30 33 31 33 20 31 0D	Information menu	On	
~XX313 0	7E 30 30 33 31 33 20 30 0D		Off(0/2 for backward compatible)	
~XX112 1	7E 30 30 31 31 32 20 31 0D	Reset	Yes	
~XX210 n	7E 30 30 32 30 30 20 n 0D	Display message on the OSD	n: 1-30 characters	
SEND to emulate Remote				
~XX140 10	7E 30 30 31 34 30 20 31 30 0D		Up	
~XX140 11	7E 30 30 31 34 30 20 31 31 0D		Left	
~XX140 12	7E 30 30 31 34 30 20 31 32 0D		Enter (for projection MENU)	
~XX140 13	7E 30 30 31 34 30 20 31 33 0D		Right	
~XX140 14	7E 30 30 31 34 30 20 31 34 0D		Down	
~XX140 15	7E 30 30 31 34 30 20 31 35 0D		V Keystone +	
~XX140 16	7E 30 30 31 34 30 20 31 36 0D		V Keystone -	
~XX140 17	7E 30 30 31 34 30 20 31 37 0D		Volume -	
~XX140 18	7E 30 30 31 34 30 20 31 38 0D		Volume +	
~XX140 20	7E 30 30 31 34 30 20 32 30 0D		Menu	
~XX140 47	7E 30 30 31 34 30 20 34 37 0D		Source	
SEND from projector automatically				
232 ASCII Code	HEX Code	Function	Projector Return	Description
when Standby/Warming/Cooling/Out of Range/Lamp fail/Fan Lock/Over Temperature/ Lamp Hours Running Out/ Cover Open			INFOn	n=0 Standby n=1 Warming n=2 Cooling n=3 Out of Range n=4 Lamp fail n=6 Fan Lock/ n=7 Over Temperature n=8 Lamp Hours Running Out
READ from projector				
232 ASCII Code	HEX Code	Function	Projector Return	Description
~XX121 1	7E 30 30 31 32 31 20 31 0D	Input Source Commands	Okn	n = 0 None n = 7 HDMI1 n = 8 HDMI2 n = 15 Displayport n = 2 VGA1 n = 3 VGA2 n = 5 Video n = 4 S-Video n = 16 HDbaseT

ADDITIONAL INFORMATION

READ from projector				
232 ASCII Code	HEX Code	Function	Projector Return	Description
~XX122 1	7E 30 30 31 32 32 20 31 0D	Software Version	OKdddd	dddd: FW version
~XX357 1	7E 30 30 33 35 34 20 31 0D	LAN FW version	Okeeeee	eeee: LAN FW version
~XX123 1	7E 30 30 31 32 33 20 31 0D	Display Mode	Okn	n = 0 None n = 1 Presentation n = 2 Bright n = 3 Movie n = 4 sRGB n = 5 User n = 7 Blackboard n = 12 DICOM SIM. n = 9 3D
~XX124 1	7E 30 30 31 32 34 20 31 0D	Power State	Okn	n=0 Off n=1 On
~XX125 1	7E 30 30 31 32 35 20 31 0D	Brightness	Okn	
~XX126 1	7E 30 30 31 32 36 20 31 0D	Contrast	Okn	
~XX127 1	7E 30 30 31 32 37 20 31 0D	Format	Okn	n = 1 4:3 n = 2 16:9 n = 3 16:10 n = 5 LBX n = 6 Native n = 7 Auto
*16:9 or 16:10 depend on Screen Type setting				
~XX128 1	7E 30 30 31 32 38 20 31 0D	Color Temperature	Okn	n = 0 Standard n = 1 Cool n = 2 Cold n = 3 Warm
~XX129 1	7E 30 30 31 32 39 20 31 0D	Projection Mode	Okn	n = 0 Front-Desktop n = 1 Rear-Desktop n = 2 Front-Ceiling n = 3 Rear-Ceiling
~XX150 1	7E 30 30 31 35 30 20 31 1D	Information	Okabbbbccddde	a = 0 Off a = 1 On bbbb: LampHour cc: source cc = 00 None cc = 02 VGA1 cc = 03 VGA2 cc = 04 S-Video cc = 05 Video cc = 07 HDMI1 cc = 08 HDMI2 cc = 15 Displayport cc = 16 HDBaseT dddd FW Version

ADDITIONAL INFORMATION

READ from projector				
232 ASCII Code	HEX Code	Function	Projector Return	Description
				e = Display mode ee = 00 None ee = 01 Presentation ee = 02 Bright ee = 03 Movie ee = 04 sRGB ee = 05 User ee = 07 Blackboard ee = 09 3D ee = 12 DICOM SIM.
~XX151 1	7E 30 30 31 35 31 20 31 0D	Model name	OKn	n = 2 XGA n = 3 WXGA n = 4 1080p n = 5 WUXGA
~XX108 1	7E 30 30 31 30 38 20 31 0D	Lamp Hours	OKbbbb	bbbb: LampHour
~XX108 2	7E 30 30 31 30 38 20 31 0D	Cumulative Lamp Hours	OKbbbbbb	bbbbbb: (5 digits) Total Lamp Hours
~XX321 1	7E 30 30 33 32 31 20 31 0D	Filter Usage Hours	OKbbbb	bbbb: Filter Usage Hours
~XX87 1	7E 30 30 38 37 20 31 0D	Network Status	Okn	n = 0 Disconnected n = 1 Connected
~XX87 3	7E 30 30 38 37 20 33 0D	IP Address	Okaaa_bbb_ccc_ddd	
~XX351 1	7E 30 30 33 35 31 20 31 0D	Fan1 speed(blower)	Okaaaa	a=0000~9999
~XX352 1	7E 30 30 33 35 32 20 31 0D	System temperature	Okaaa	a=000~999
~XX353 1	7E 30 30 33 35 33 20 31 0D	Serial number	Okaaaaaaaaa aaaaaaaa	a=serial number string
~XX354 1	7E 30 30 33 35 34 20 31 0D	Closed Captioning	Oka	a = 0 off a = 1 cc1 a = 2 cc2
~XX355 1	7E 30 30 33 35 35 20 31 0D	AV Mute	Oka	a = 0 Off a = 1 On
~XX356 1	7E 30 30 33 35 36 20 31 0D	Mute	Oka	a = 0 Off a = 1 On
~XX358 1	7E 30 30 33 35 38 20 31 0D	Current watt	Okaaaa	a = 0000~9999

ADDITIONAL INFORMATION

IR remote codes

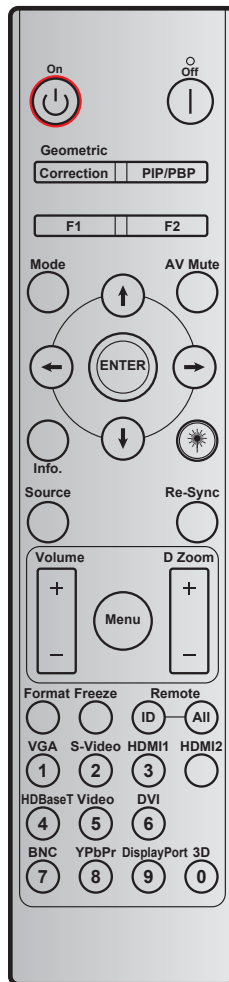

Key	Key Symbol	Custom code		Data code	Printing-key definition	Description
		Byte 1	Byte 2	Byte 3		
Power off		32	CD	2E	Off	Press to turn off the projector.
Power on	⏻	32	CD	02	On	Press to turn on the projector.
PIP/PBP	PIP/PBP	32	CD	78	PIP/PBP	Press to use the PIP/PBP function.
Geometric Correction	Correction	32	CD	96	Geometric Correction	Geometric correction.
F2	F2	32	CD	27	F2	By default Zoom.
F1	F1	32	CD	26	F1	By default Test Pattern.
Mode	Mode	32	CD	95	Mode	Display mode menu on/ off.
Up arrow	⬆	32	CD	C6	Up arrow	Use ⬆⬇⬅➡ to select items or make adjustments to your selection.
Down arrow	⬇	32	CD	C7	Down arrow	
Left arrow	⬅	32	CD	C8	Left arrow	
Right arrow	➡	32	CD	C9	Right arrow	
AV mute		32	CD	03	AV Mute	Press to turn off/ on projector built-in speaker.

ADDITIONAL INFORMATION

Key		Custom code		Data code	Printing-key definition	Description
		Byte 1	Byte 2	Byte 3		
Enter	ENTER	32	CD	C5	ENTER	Confirm your item selection.
Info.		32	CD	25	Info.	Display projector information.
Laser		N/A	N/A	N/A		Use as laser pointer.
Source		32	CD	18	Source	Press "Source" to select an input signal.
Re-Sync	Re-Sync	32	CD	04	Re-Sync	Automatically synchronize the projector to the input source.
Menu	Menu	32	CD	88	Menu	Press "Menu" to launch the on-screen display (OSD) menu. To exit OSD, Press "Menu" again.
Volume	+	32	CD	09	Volume +	Press to increase the volume.
	-	32	CD	0C	Volume -	Press to decrease the volume.
D Zoom	+	32	CD	08	D Zoom +	Use ▲ to zoom in the projected image.
	-	32	CD	0B	D Zoom -	Use ▼ to zoom out the projected image.
Format	Format	32	CD	15	Format	Press to choose the projector format.
Freeze	Freeze	32	CD	06	Freeze	Press to freeze the projector image.
Remote	ID	32	CD	3201 ~ 3299		Press until Power LED is flashing then press 01~99 to set the particular remote code.
	ALL	32	CD	32CD		
1/VGA		32	CD	8E	1/VGA	<ul style="list-style-type: none"> Press to choose VGA source. Use as numeric keypad number "1".
2/S-Video		32	CD	1D	2/S-Video	<ul style="list-style-type: none"> Press to choose S-video source. Use as numeric keypad number "2".
3/HDMI1		32	CD	16	3/HDMI	<ul style="list-style-type: none"> Press to choose HDMI source. Use as numeric keypad number "3".
HDMI2		32	CD	9B	HDMI2	Press to choose HDMI source.
4/HDBaseT		32	CD	70	4/HDBaseT	<ul style="list-style-type: none"> Press to choose HDBaseT source. Use as numeric keypad number "4".
5/Video		32	CD	1C	5/Video	<ul style="list-style-type: none"> Press to choose composite video source. Use as numeric keypad number "5".
6		32	CD	19	6	Use as numeric keypad number "6".
7		32	CD	1A	7	Use as numeric keypad number "7".
8/YPbPr		32	CD	17	8/YPbPr	<ul style="list-style-type: none"> Press to choose component video source. Use as numeric keypad number "8".
9/DisplayPort		32	CD	9F	9/DisplayPort	<ul style="list-style-type: none"> Press to choose DisplayPort. Use as numeric keypad number "9".
0/3D		32	CD	89	0/3D	<ul style="list-style-type: none"> Press to choose 3D source. Use as numeric keypad number "0".

Note: If the projector supports Dynamic Eco / Image Care features and AV Mute is pressed, the power consumption of the lamp becomes 30%.

ADDITIONAL INFORMATION

Using the Information button

The Information function ensures easy setup and operation. Press the “?” button on the keypad to open the Information menu.

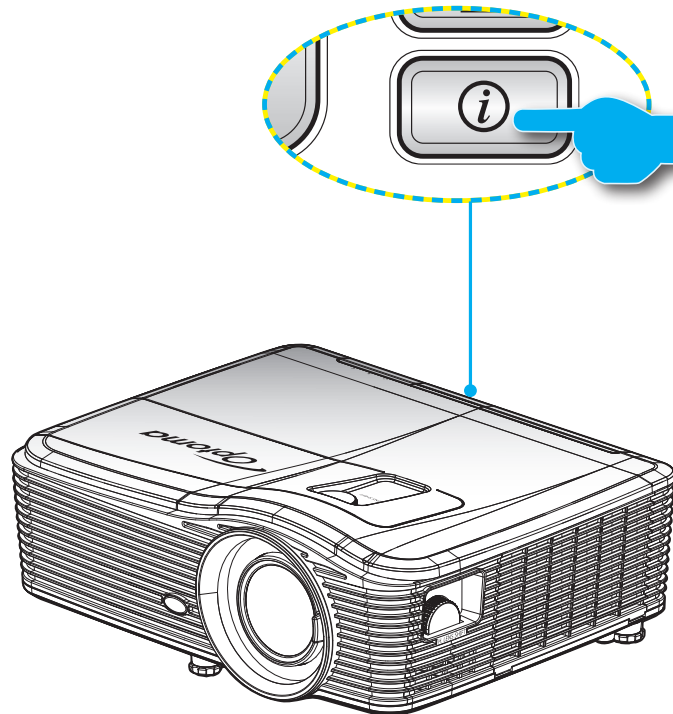

- **Information** button functions only when no input source is detected.







Information		
S/N Number		xxxxxxxxxx
F/W Version	Main	C01
	MCU	C01
	LAN	C01
Current Input Source		VGA 1
Resolution		1280x800
Refresh Rate		60.00 Hz
Lamp Hours		
	Bright	0 H
	Eco	0 H
	Power	0 H
Filter Hour		0 H
Projector ID		0
Remote Code		0
Remote Code (Active)		0
IP Address		192.168.1.1
Network Status		Connected
↩ Exit		

ADDITIONAL INFORMATION

Troubleshooting

If you experience a problem with your projector, please refer to the following information. If a problem persists, please contact your local reseller or service center.

Image problems

-  *No image appears on-screen*
- Ensure all the cables and power connections are correctly and securely connected as described in the "Installation" section.
 - Ensure the pins of connectors are not crooked or broken.
 - Check if the projection lamp has been securely installed. Please refer to the "Replacing the Lamp" section.
 - Make sure you have removed the lens cap and the projector is switched on.
-  *Image is out of focus*
- Make sure the Lens cap is removed.
 - Adjust the Focus Lever on the projector lens.
 - Make sure the projection screen is between the required distance from the projector. (Please refer to pages 69-73).
-  *The image is stretched when displaying 16:9 DVD title*
- When you play anamorphic DVD or 16:9 DVD, the projector will show the best image in 16:9 format on projector side.
 - If you play the LBX format DVD title, please change the format as LBX in projector OSD.
 - If you play 4:3 format DVD title, please change the format as 4:3 in projector OSD.
 - If the image is still stretched, you will also need to adjust the aspect ratio by referring to the following:
 - Please setup the display format as 16:9 (wide) aspect ratio type on your DVD player.
-  *Image is too small or too large*
- Move the projector closer to or further from the screen.
 - Press "Menu" on the projector panel, go to "Display-->Format". Try the different settings.
-  *Image has slanted sides:*
- If possible, reposition the projector so that it is centered on the screen and below the bottom of the screen.
 - Use "Display-->V Keystone" from the OSD to make an adjustment.
-  *Image is reversed*
- Select "Setup-->Projection" from the OSD and adjust the projection direction.

ADDITIONAL INFORMATION

- ❓ *Blurry double image*
 - Press "3D Format" button and switch to "Off" to avoid normal 2D image is blurry double image.
- ❓ *Two images, side-by-side format*
 - Press "3D Format" button and switch to "SBS" for input signal is HDMI 1.3 2D 1080i side-by-side.
- ❓ *Image does not display in 3D*
 - Check if the battery of 3D glasses is drained.
 - Check if the 3D glasses is turned on.
 - When the input signal is HDMI 1.3 2D (1080i side-by-side half), press "3D Format" button and switch to "SBS".

Other problems

- ❓ *The projector stops responding to all controls*
 - If possible, turn off the projector, then unplug the power cord and wait at least 20 seconds before reconnecting power.
- ❓ *Lamp burns out or makes a popping sound*
 - When the lamp reaches its end of life, it will burn out and may make a loud popping sound. If this happens, the projector will not turn on until the lamp module has been replaced. To replace the lamp, follow the procedures in the "Replacing the Lamp" section on pages 63-64.

Remote control problems

- ❓ *If the remote control does not work*
 - Check the operating angle of the remote control is within $\pm 15^\circ$ both horizontally and vertically of the IR receivers on the projector.
 - Make sure there are not any obstructions between the remote control and the projector. Move to within 5 m (16 ft) of the projector.
 - Make sure batteries are inserted correctly.
 - Replace batteries if they are exhausted.

Warning indicators





When the warning indicators (see below) come on, the projector will automatically shutdown:

- "LAMP" LED indicator is lit red and if "On/Standby" indicator flashes red.
- "TEMP" LED indicator is lit red and if "On/Standby" indicator flashes red. This indicates the projector has overheated. Under normal conditions, the project can be switched back on.
- "TEMP" LED indicator flashes red and if "On/Standby" indicator flashes red.

Unplug the power cord from the projector, wait for 30 seconds and try again. If the warning indicator lights up again, please contact your nearest service center for assistance.

ADDITIONAL INFORMATION

LED lightning messages

Message	 Power LED	 Power LED	 Temp-LED	 Lamp-LED
	(Red)	(Blue)	(Red)	(Red)
Standby state (Input power cord)	Steady light			
Power on (Warming)		Flashing (0.5 sec off / 0.5 sec on)		
Power on and Lamp lighting		Steady light		
Power off (Cooling)		Flashing (0.5 sec off / 0.5 sec light). Back to red steady light when cooling fan turns off.		
Quick Resume (100 secs)		Flashing (0.25 sec off / 0.25 sec light)		
Error (Lamp failure)	Flashing			Steady light
Error (Fan failure)	Flashing		Flashing	
Error (Over temp.)	Flashing		Steady light	
Standby State (Burn in mode)		Flashing		
Burnin (Warming)		Flashing		
Burnin (Cooling)		Flashing		

- Power off:

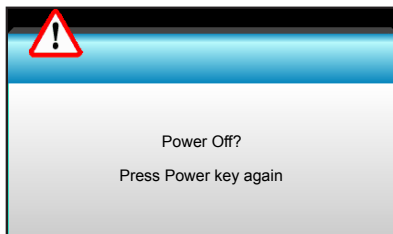

- Lamp warning:

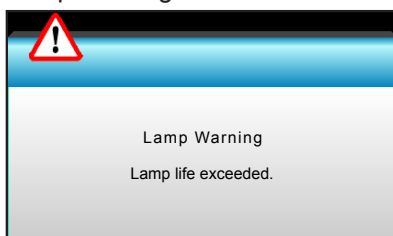

- Temperature warning:

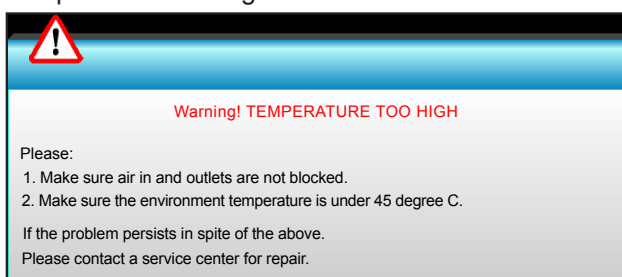

ADDITIONAL INFORMATION

- Fan failed:

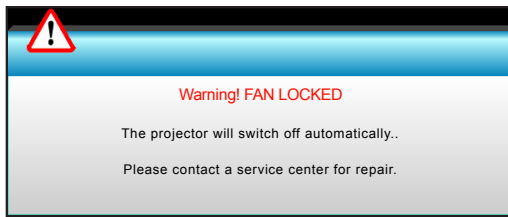

- Out of display range:

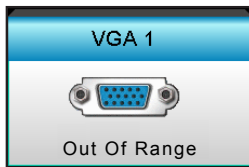

ADDITIONAL INFORMATION

Specifications

Optical	Description
Maximum resolution	- DP: 1920x1200@60Hz - HDMI: 1920x1200@60Hz (RB)
Lens	- Fixed lens and manual focus - WXGA/1080P/WUXGA/XGA: 11.66mm
Lamp	- ECO Mode <= 0.5 W @110/220VAC - Active Mode (>0.5W; <3W) @110/220VAC
Image size (diagonal)	- XGA: 30" ~ 300" - WXGA: 27.97" ~ 302" - 1080P: 28.59" ~ 303" - WUXGA: 29.38" ~ 305.6"
Projection distance	- XGA: 0.5 ~ 5m - WXGA: 0.5 ~ 5.4m - 1080p: 0.5 ~ 5.3m - WUXGA: 0.5 ~ 5.2m

Electrical	Description
Inputs	HDMI, HDMI+MHL(2.0), USB-B mini connector (Firmware upgrade), S-Video port, DisplayPort, VGA2 In/YPbPr connector, VGA2 In/YPbPr connector, Audio3-In (Video/S-Video) port, Audio1-In(VGA1), Audio2-In(VGA2) port
Outputs	VGA out connector, Audio-Out port, USB Power Out(1.5A)
Wired LAN port	1 x RJ-45 (10/100 BASE-T/100 BASE-TX)
Service port	RS232C connector, 3D Sync VESA, Wired Remote
Color reproduction	1073.4 Million color
Scan rate	- Horizontal Scan rate: 15.375~91.146 KHz - Vertical Scan rate: 24~ 85 Hz (120Hz for 3D feature)
Sync compatibility	Separate Sync
Built-in speaker	Yes, 10W
Power requirement	100 - 240V AC 50/60Hz
Input current	2.5-1.0 A
Power consumption (typical value)	
ECO mode off	365W±3%
ECO mode	292W±3%

Mechanical	Description
Installation orientation	Front-Desktop, Rear-Desktop, Front-Ceiling, Rear-Ceiling
Dimensions	- 424 mm (W) x 344 mm (D) x 120 mm (H) (without feet) - 424 mm (W) x 344 mm (D) x 160 mm (H) (with feet)
Weight	5.2 kg
Environmental conditions	Operating: 5 ~ 40°C in Bright mode (normal mode) 10% to 85% humidity (non-condensing)
	Operating: 5 ~ 45° C in ECO mode 10% to 85% humidity (non-condensing)

Note: All specifications are subject to change without notice.



ADDITIONAL INFORMATION

Optoma global offices

For service or support, please contact your local office.



USA

3178 Laurelview Ct.
Fremont, CA 94538, USA
www.optomausa.com
[com](http://www.optomausa.com)

 888-289-6786
 510-897-8601
 services@optoma.com



Canada

3178 Laurelview Ct.
Fremont, CA 94538, USA
www.optomausa.com
[com](http://www.optomausa.com)

 888-289-6786
 510-897-8601
 services@optoma.com

Latin America

3178 Laurelview Ct.
Fremont, CA 94538, USA
www.optomausa.com

 888-289-6786
 510-897-8601
 services@optoma.com



Europe

Unit 1, Network 41, Bourne End Mills
Hemel Hempstead, Herts,
HP1 2UJ, United Kingdom
www.optoma.eu
Service Tel : +44 (0)1923 691865

 +44 (0) 1923 691 800
 +44 (0) 1923 691 888
 service@tsc-europe.com



Benelux BV

Randstad 22-123
1316 BW Almere
The Netherlands
www.optoma.nl

 +31 (0) 36 820 0253
 +31 (0) 36 548 9052



France

Bâtiment E
81-83 avenue Edouard Vaillant
92100 Boulogne Billancourt, France

 +33 1 41 46 12 20
 +33 1 41 46 94 35
 savoptoma@optoma.fr



Spain

C/ José Hierro,36 Of. 1C
28522 Rivas VaciaMadrid,
Spain

 +34 91 499 06 06
 +34 91 670 08 32



Deutschland

Wiesenstrasse 21 W
D40549 Düsseldorf,
66799
Germany

 +49 (0) 211 506 6670
 +49 (0) 211 506
 info@optoma.de

Scandinavia



Lerpeveien 25
3040 Drammen
Norway

 +47 32 98 89 90
 +47 32 98 89 99
 info@optoma.no

PO.BOX 9515
3038 Drammen
Norway

Korea

WOOMI TECH.CO.,LTD.
4F,Minu Bldg.33-14, Kangnam-Ku,
seoul,135-815, KOREA

 +82+2+34430004
 +82+2+34430005



Japan

東京都足立区綾瀬3-25-18
株式会社オーエス
コンタクトセンター:0120-380-495

 info@os-worldwide.com
www.os-worldwide.com



Taiwan

12F., No.213, Sec. 3, Beixin Rd.,
Xindian Dist., New Taipei City 231,
Taiwan, R.O.C.
www.optoma.com.tw

 +886-2-8911-8600
 +886-2-8911-6550
 services@optoma.com.tw
asia.optoma.com



Hong Kong

Unit A, 27/F Dragon Centre,
79 Wing Hong Street,
Cheung Sha Wan,
Kowloon, Hong Kong

 +852-2396-8968
 +852-2370-1222
www.optoma.com.hk

China

5F, No. 1205, Kaixuan Rd.,
Changning District
Shanghai, 200052, China

 +86-21-62947376
 +86-21-62947375
www.optoma.com.cn

