

SCALE 1:5

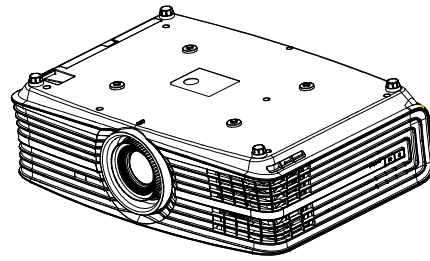

SCALE 1:5

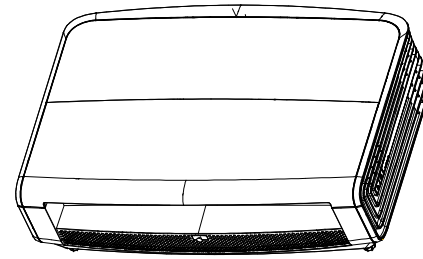

SCALE 1:5

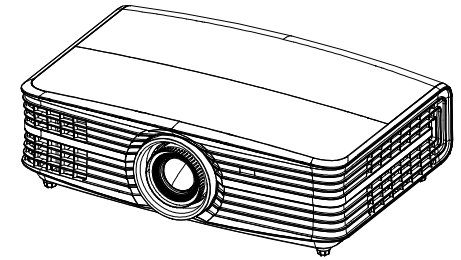

SCALE 1:5

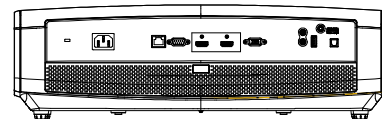
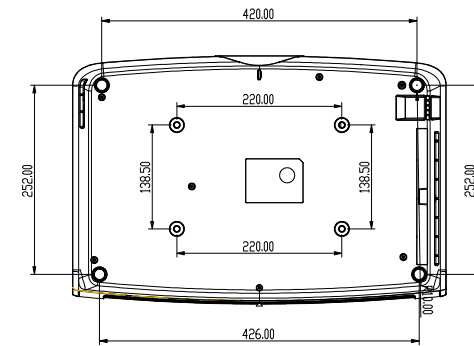
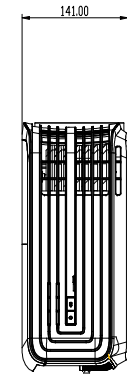
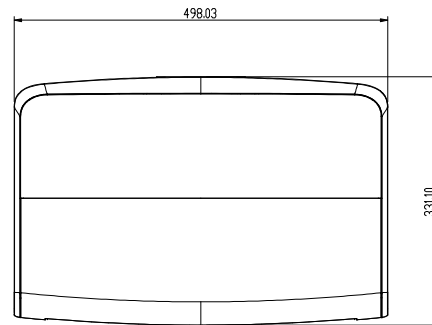
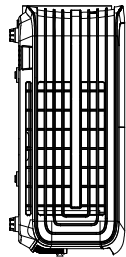
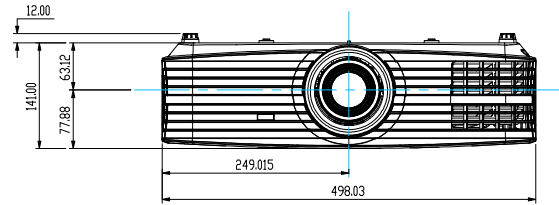

SCALE 1:5

				LIMITS UNLESS OTHERWISE NOTED		DRAWN rex wu 20161219		Coretronic Corporation	
				1-6	11	300-1000	11	CHK. rex wu 20161219	NAME
				6-30	12	1000-2000	12	APPD. Daniel 20161219	U1-78V_6
				30-100	13	2000-	20	TITLE UHD60	PART NO. D078V01G001
Rev. A	rex wu	20161219	FORMAL RELEASE	X	100-300	13	2000-	SCALE 1:1	FINISH
Rev. Initiator	Date		Description	ECR NO.	100-300	13	ANGLE	UNIT mm	Rev.A
									1 OF 1